



---

# **UNIT 2**

## **COMBUSTION**

---





# Combustion in SI and CI Engines



## *Course Contents*

- 7.1. Introduction to S.I. engine
- 7.2. Combustion Related Concepts and Definitions
- 7.3. Ignition Limit
- 7.4. Stages of combustion
- 7.5. Factors affecting ignition lag
- 7.6. Factors affecting the flame propagation
- 7.7. Abnormal combustion and knocking in S.I. engines
- 7.8. Effect of Engine Variables on Detonation in S.I. Engines
- 7.9. Control of knocking
- 7.10. S.I. engine Combustion Chamber Design
- 7.11. Different Types of Combustion Chambers for S.I. Engines in Use:
- 7.12. Introduction to C.I engine
- 7.13. Combustion Stages in C.I. Engines
- 7.14. Effect of Engine Variables on Delay Period
- 7.15. Knock in C.I. Engines (Abnormal Combustion)
- 7.16. Factors affecting the knocking in C.I engine
- 7.17. Comparison of the knocking in S.I. and C.I. engines
- 7.18. Combustion Chamber Design for C.I. Engines
- 7.19. Classification of Combustion Chambers for C.I. Engines

## 7.1. Introduction

- In Spark Ignition (S.I.) engine, fuel and air is mixed outside the engine cylinder in carburetor in proper proportion.
- Combustion is chemical reaction between hydrogen and carbon in fuel with oxygen in air. It produces  $\text{CO}_2$  and  $\text{H}_2\text{O}$  and liberates energy in the form of heat. Actual process of combustion is very complicated and lot of research is going on since many years.
- During combustion, large amount of heat is generated which is utilized to run the I.C engine.
- Combustion in S.I. engine requires following conditions:
  - (1) Proper proportion of air-fuel mixture should be compressed to required level (compression ratio = 6 to 10)
  - (2) Spark should take place with required intensity.
  - (3) Combustion should start at spark plug, and the flame should propagate in combustion chamber.

## 7.2. Combustion Related Concepts and Definitions

- The internal combustion engines derive their energy in the form of heat by combustion of homogeneous mixture of fuel and air in the combustion chamber.
- An enormous amount of research has been carried out, both theoretical and experimental, regarding the burning of this homogeneous mixture, but in actual practice the mixture inside the cylinder is never homogeneous.
- The reasons for such existent of heterogeneous mixtures in the cylinder may be non-uniform distribution of fuel and air in the combustion chamber or due to the dilution of mixture by the left over residual (burnt) gases in the clearance space of the cylinder of its previous stroke or for other reasons.
- The combustion problem of such mixtures is quite complex and intricate.
- However, the researches carried out in case of combustion of homogeneous mixtures in spherical bomb by igniting the fuel by a spark at a point have shown that there is a development of a flame defined as gas rendered luminous by liberation of chemical energy, which starts from the point of ignition and spreads continuously in outward direction.
- If the flame travels from the point of ignition up to the end of combustion chamber without any change in speed and shape, the combustion is said to be *normal*.
- If the mixture of fuel and air ignites prior to reaching the flame front, this phenomenon of combustion is called *auto-ignition*.
- The temperature at which the fuel will ignite itself without a flame is called *self-ignition temperature (S.I.T.)*.
- The auto-ignition of fuel is affected by various factors like density of charge (mixture of fuel and air); its temperature and pressure, turbulence and the air-fuel ratio.
- In case of normal combustion the forward boundary of reaction zone of a flame is called *flame front*. It is defined as the surface or area between the luminous region and the dark region of the unburned charge.
- The velocity of flame by which it moves in space is called *spatial velocity* which depends upon the shape and size of the combustion chamber.
- It has two components viz. transformation velocity and gas velocity.

- Former is defined as the relative velocity of burned gases with which the flame front moves from burned to unburned gases and it is the velocity by which the unburned gases approach the burning zone.
- The combustion is defined as the rapid and high temperature oxidation of fuel with liberation of heat energy.
- The main constituents of most fuels are carbon (C) and hydrogen (H<sub>2</sub>) and their burning involves the rapid oxidation of C to CO or CO<sub>2</sub> and of H<sub>2</sub> to H<sub>2</sub>O. Usually the combustion processes take place in gaseous phase.
- The requirement for initiating a combustion process are the presence of a combustible mixture of air and fuel, a means for initiating the combustion, the formation of a flame and its propagation across the combustion chamber.

### 7.3. Ignition Limit

- The flame inside the combustion chamber will propagate from spark plug to end of combustion chamber only if temperature inside the cylinder exceeds 1500 K and A/F ratio is within combustible limit i.e. between 9:1 to 21:1.
- Beyond this limit it may be too lean or too rich and practically the combustion will not be possible. As we know that Stoichiometric A/F ratio for isooctane (C<sub>8</sub>H<sub>18</sub>) is approximately 15:1.

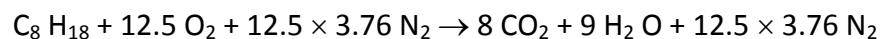

- If combustion is complete, CO<sub>2</sub> and H<sub>2</sub>O will come out in exhaust. If mixture is lean, excess air comes out in exhaust with CO<sub>2</sub> and H<sub>2</sub>O. If mixture is rich, incomplete combustion will take place resulting in reduced power and producing CO<sub>2</sub>, H<sub>2</sub>O and CO in exhaust.

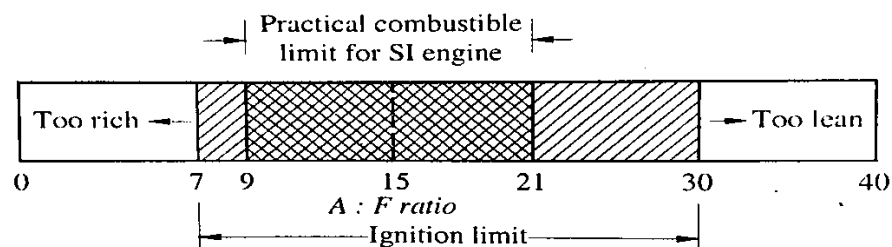

Fig.7. 1 Ignition Limit Hydrocarbons

### 7.4. Stages of combustion

- In I.C. engine, if inlet and exhaust valves are closed and piston moves from bottom dead centre (BDC) to top dead centre (TDC), compression will take place and similarly from top to bottom, expansion will take place. If combustion does not take place during this process, the pressure (p) versus crank angle (θ) diagram obtained is known as Motoring curve.
- Theoretical p- θ diagram where spark occurs at TDC, pressure suddenly rises due to combustion and, then expansion of combustion products take place.

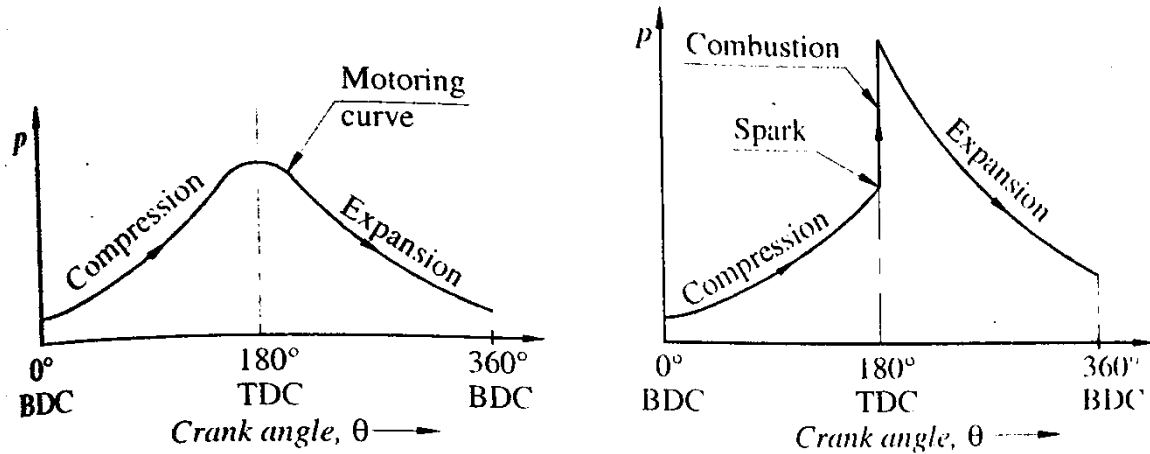

Fig. 7.2 (a)  $p - \theta$  diagram without combustion (non-firing)

(b) theoretical  $p - \theta$  diagram with combustion

- The actual  $p - \theta$  diagram with combustion is very complicated but as per this figure it is divided into three stages namely;
  - Stage I = A to B = Ignition lag,
  - Stage II = B to C = Flame propagation,
  - Stage III = C onwards = After burning.
- To achieve maximum advantage of high pressure generated during combustion, peak pressure should be after and near to the TDC.
  - If peak pressure is before TDC, it produces negative force on the piston which may damage the piston, piston rod, and crank shaft.
  - If peak pressure is after and far from TDC, force generated due to combustion cannot be fully utilized.
- Considering above fact spark timing (point A) should be selected that maximum pressure (point C) will be after and near TDC.

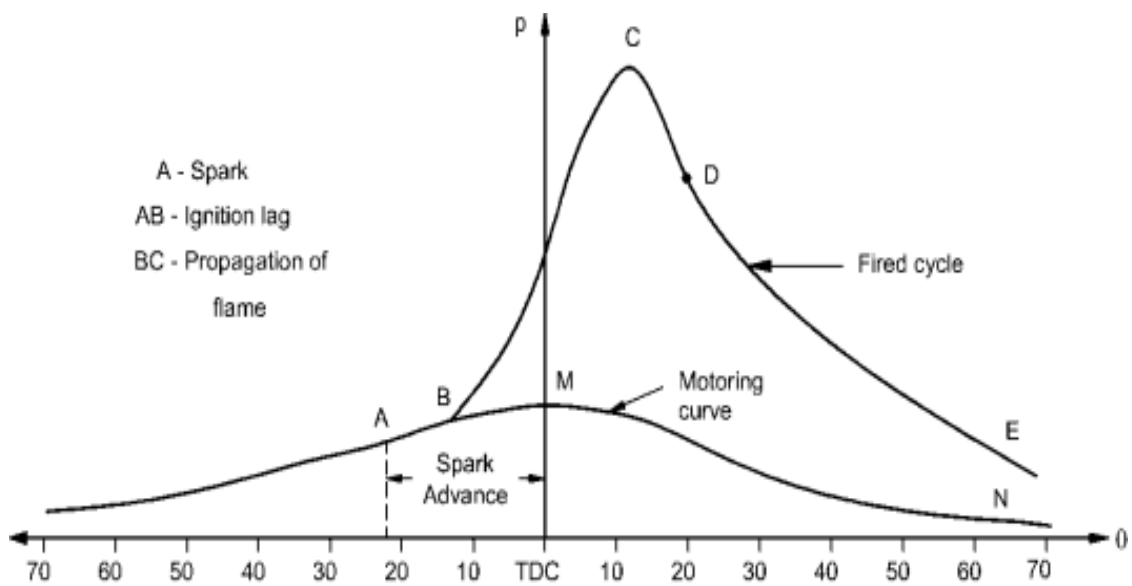

Fig 7.3 Actual  $p - \theta$  diagram for S.I. engine

### Stage I - Ignition lag:

- Ignition lag is the duration between spark (point A) and starting of combustion (point B).
- At point B, first rise of pressure detected and the actual curve differs from motoring curve. So time interval between spark (point A) and first pressure rise (point B) is known as ignition lag and generally it is expressed in terms of crank angle  $\theta$ .
- Ignition lag is also known as preparation phase during which spark, chemical process takes place, and flame generates. In SI engine combustion ignition lag is very important and it should be as small as possible for getting more power.

### Stage II - Flame propagation:

- The time duration between point B (combustion starts) and point C (Peak pressure) is known as flame propagation.
- The most of the heat is generated during this phase. Normally spark will occur (Point A) approximately  $30^\circ$  to  $35^\circ$  before TDC, so that peak pressure (Point C) is obtained  $5^\circ$  to  $10^\circ$  after TDC at cruising speed.
- As speed vary this spark timing should vary forgetting peak pressure at  $5^\circ$  to  $10^\circ$  after TDC.

### Stage III - After burning:

- Theoretically we can say that combustion should be completed at point C i.e. at maximum pressure in Fig.
- But actually combustion will continue after point C i.e. during expansion stroke which is known as after burning.
- It may be due to type of fuel, rich mixture etc. About 10% of heat may be liberated during this stage.

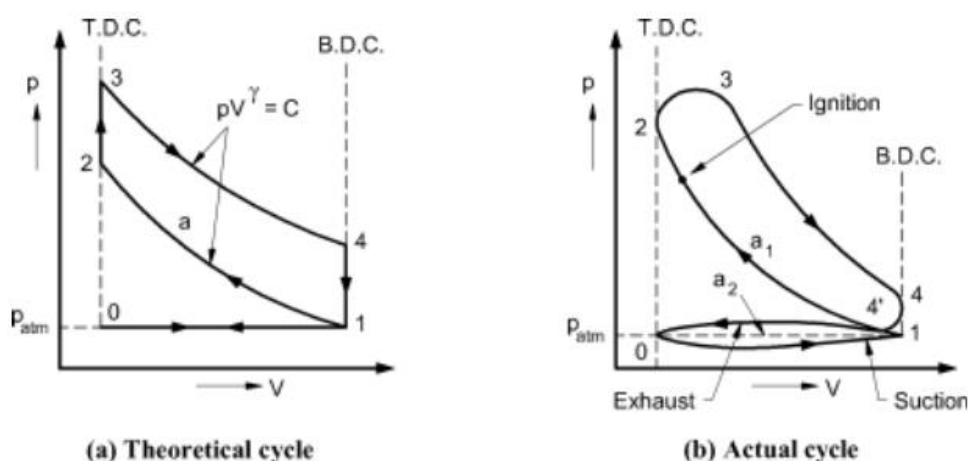

Fig 7. 4 Theoretical and Actual p-V diagram for S.I. engine

- In S.I engine, combustion takes place at constant volume and in C.I. engine at constant pressure. Area of actual p-V diagram is always less than theoretical p-V diagram. Area of p-V diagram means work done and it should be as large as possible.
- So to achieve this, actual p-V diagram should be close to theoretical p-V diagram. To achieve this, process of combustion should be as fast as possible i.e. timing or crank angle of 1<sup>st</sup> and 2<sup>nd</sup> phase should be as small as possible.

## 7.5. Factors affecting ignition lag

### 1. A:F ratio:

- Maximum power is produced at slightly richer mixture. At maximum power, heat generated is maximum, which will reduce Ignition-lag timing as shown.

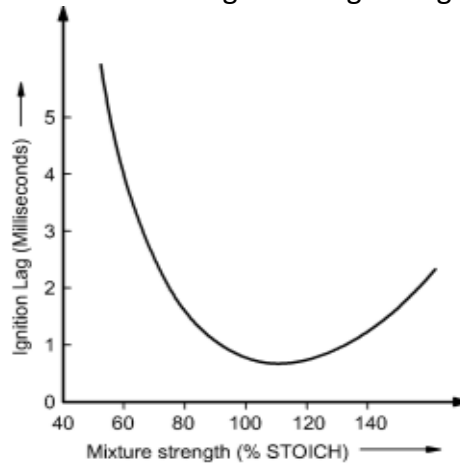

Fig.7. 5 Effect of A/F Ratio on Ignition Lag

### 2. Fuel:

- Chemical composition and nature of fuel plays vital role in combustion. The fuel with higher self-ignition temperature has longer ignition lag period.

### 3. Initial temperature and pressure:

- The chemical reaction between fuel and air greatly depends on temperature and pressure. As temperature and pressure increases reaction becomes fast which reduces ignition lag. Any factor which increases in-cylinder temperature or pressure will lead to decrease the ignition lag period. These factors may be supercharging, increasing compression ratio, retarding –the spark timing, etc.

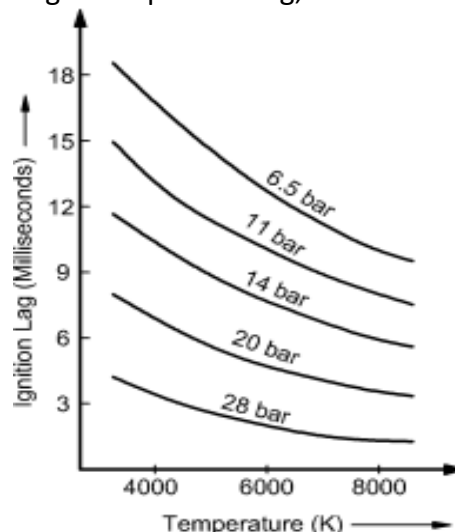
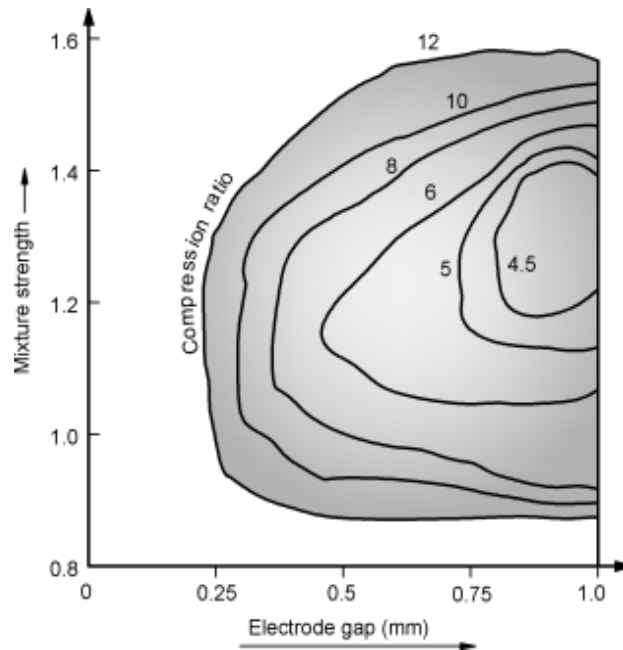

Fig.7. 6 Effect of Pressure and Temperature on Ignition Lag

### 4. Electrode gap:

- In a spark plug, distance between positive and negative electrode is known as electrode gap. The effect of electrode gap on mixture strength for different compression. As the electrode gap increases, higher voltage is required to produce the spark.





*Fig.7. 7 Effect of Electrode gap on A:F ratio required for different compression ratio*

- Following conclusion were made.
  - a) For small electrode gap (i.e. 0.25 mm) range of A:F ratio for development of flame nucleus is reduced.
  - b) For low compression ratio (say for CR=5) higher electrode gap is required.
  - c) As electrode gap increases the range of mixture strength increases.
  - d) As compression ratio increases combustion will be possible with small electrode gap.

#### 5. Turbulence:

- Turbulence means irregular motion of the charge inside the combustion chamber. Turbulence is directly proportional to engine speed.
- Ignition lag is not much affected by increasing the turbulence. So, engine speed does not affect the ignition lag measured in milli seconds but ignition lag in crank angle increases with speed.
- Therefore, angle of advance for spark timing increases with increasing speed and decreases with decreasing speed to maintain a constant ignition lag. Therefore, in all S.I engine automatic spark advance and retard mechanism is used to maintain constant ignition lag.

### 7.6. Factors affecting the flame propagation

- Flame propagation is very important in combustion process of S.I engines. The flame propagation depends on velocity of flame from spark plug to cylinder wall. The fast flame propagation will improve combustion and economy. A : F ratio and turbulence are major factors affect the flame propagation. Following are the factors that affect the flame propagation.

#### 1. A : F Ratio:

- As we know that maximum power is generated at slightly richer mixture. Therefore, maximum flame speed and flame propagation take place at approximately 10% richer mixture. For lean or too rich mixture flame propagation takes large time.

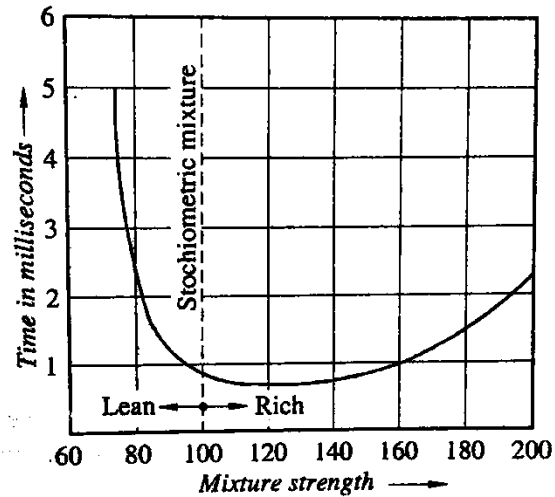

Fig. 7. 8 Effect of A/F Ratio on flame propagation

## 2. Compression Ratio (CR):

- Higher value of compression ratio increases the pressure and temperature of the working mixture and decreases the concentration of residual gases in the engine cylinder. This will speed up 1<sup>st</sup> phase (Ignition lag) and 2<sup>nd</sup> phase (flame propagation) of combustion. The drawback of increasing the in-cylinder temperature and pressure is to increase the possibility of detonation or knocking.

## 3. Intake temperature and pressure:

- As discussed earlier, as the intake temperature and pressure increases, the flame speed and flame propagation also increases.

## 4. Load on the Engine:

- As the load on an engine increases, the cycle pressure and temperature also increases. Hence the flame speed increases.

## 5. Turbulence:

- Irregular motion of charge entered inside the cylinder is known as turbulence. Turbulence is also generated inside the cylinder during compression by suitable design of the combustion chamber. In S.I. engine for combustion of fuel, the turbulence is very important factor because flame speed is directly proportional to the turbulence of the mixture. Advantages of turbulence are as follows:

- It provides better mixing of air and fuel.
- It increases the rate of heat transfer.
- Accelerate the chemical reaction, therefore combustion is improved.
- Flame propagation decreases and flame speed increases, therefore, weak (lean) mixture can also be burnt efficiently.

Besides all above advantages there are few disadvantages of high turbulence:-

- Due to high turbulence high heat transfer rate may cool the flame generated which lead to reduce flame velocity and flame may extinguish.

## 6. Engine Speed;

- Turbulence generated is linearly proportional to engine speed. So as engine speed increases, turbulence increases which will increase the flame propagation.

## 7.7. Abnormal combustion and knocking in S.I. engines

- In normal combustion the flame generated from spark plug and it travels to the end of cylinder wall smoothly without any disturbance.
- Under some operating conditions abnormal combustion may occur which will affect the combustion process. This results into the decreased power output, rough running of engine, and damage the engine parts also.
- Abnormal combustions are mainly of two types :
  - a) Detonation or knocking, and
  - b) Surface ignition.

### 1. Detonation or knocking

- The temperature at which fuel will be self-ignited without any external source (like flame front, or spark, etc.) is known as “Self-Ignition Temperature” (SIT).
- This process of ignition is called “auto ignition”.
- In normal combustion all the charge in the engine cylinder is ignited by flame front
- In knock combustion most of the charge is ignited by flame front but some amount of change will “auto ignite”.

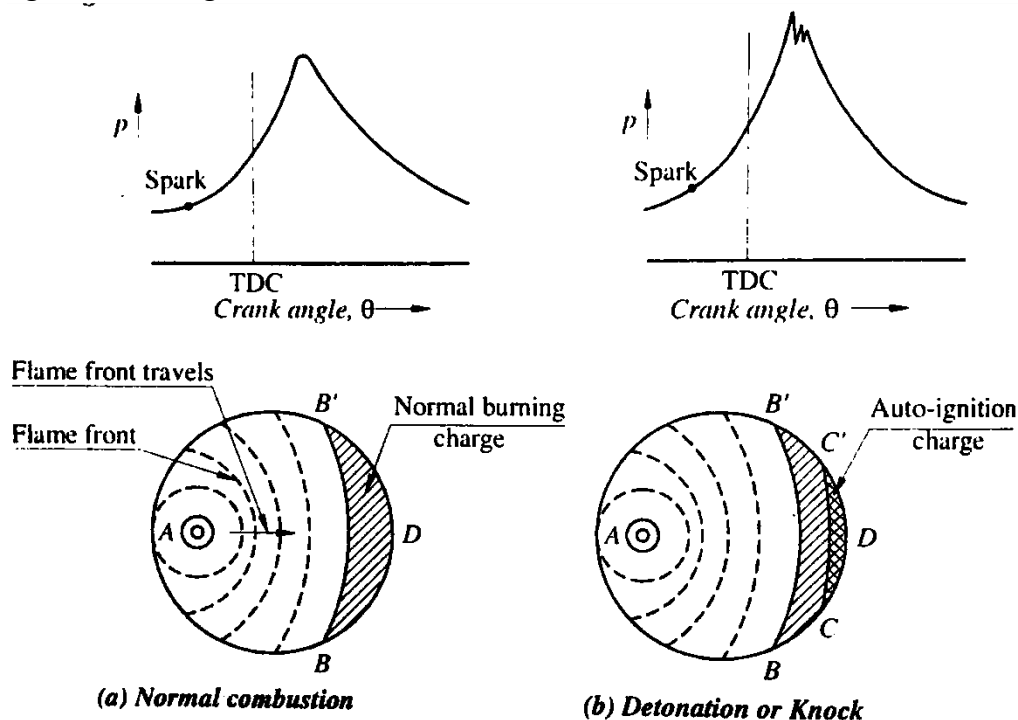

Fig.7. 9 Normal combustion and detonation

- Knocking or detonation is due to auto ignition of end charge before reaching the flume front in that part of the combustion chamber.
- In normal combustion flame will travel from A to BB' to D. Combustion of end charge between BB' and D takes place by flame front only
- The flame from A travels towards BB' two things will happen during this process, which will create the knocking.
  1. End charge between BB and D receives heat by flame front, and
  2. This end charge is compressed because of flame front.

- Both these factors will increase the temperature of end charge and reaches up to the self-ignition temperature (SIT). Therefore, the charge between CC' and D auto ignites before the flame is reached, which is known as knocking.
- Due to this knocking high pitching metallic sound is produced, combustion becomes erratic, power is drastically reduced and whole engine vibrates.

Salient features of knocking: -

1. Peak pressure for normal combustion is approximately 50 bar while during knocking it increases to 150 to 170 bar.

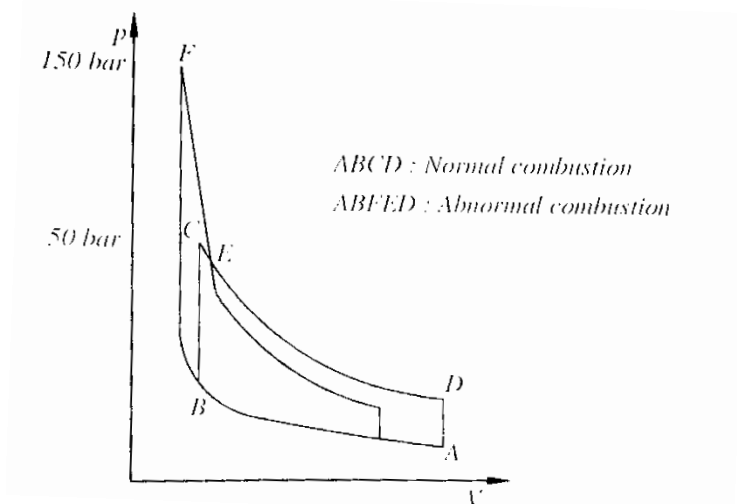

Fig.7. 10 Pressure rise due to knocking

2. Only 5% of total charge can produce the severe knock.
3. High pitching metallic sound is produced during knocking.
4. Inside the cylinder high velocity and pressure waves are produced.

## 2. Effects of detonation or knocking

### 1. Decrease In power output and efficiency:

- Heat transfer to cooling water increases during knocking, therefore, power output and efficiency of the engine decreases.

### 2. Pre-ignition:

- As rate of heat transfer increases, some parts inside the cylinder like valves, spark plug, etc. get overheated. Due to overheating hot spot ignition of charge occurs before the spark. This phenomenon is known as Pre-ignition and pre-ignition is very danger which may damage the engine and blast may also take place.

### 3. Mechanical damage:

- High pressure waves with large amplitude (190-210 bar) are generated during knocking. This will lead to wear different parts of engine like piston, cylinder, cylinder head, valves etc. Due to high heat transfer rate piston and piston rings may damage and even melts also. Spark plug is also over heated and may became hot spot.

### 4. Noise and Roughness:

- Due to high pressure waves engine parts vibrate, engine runs rough, and loud pulsating noise is created.

### 3. Abnormal Combustion (Surface ignition)

- Knocking or detonation discussed above is combustion knock, and it is due to end charge combustion by self-ignition before reaching the flame front. It is also known as spark knock.
- Abnormal combustion also occurs by surface ignition. In surface ignition, ignition will not occur by spark plug but due to any hot spot in combustion chamber.
- During combustion some of the part receives heat from combustion and becomes very hot and it acts as a spark plug. This hot part may be exhaust valve head, any carbon particle deposited on the piston or cylinder head or spark plug electrode.
- Carbon deposits also occupy some space inside the cylinder. So increases the compression ratio which causes for high temperature. Also carbon deposits are poor heat conductor which acts as an insulator leads to decreases the heat transfer and finally causes high in cylinder temperature.
- The surface ignition occurs before (pre-ignition) or after (post-ignition) normal ignition. Pre ignition is very dangerous as it creates the negative work which may damage the engine parts like piston, piston rod, and crank shaft. Pre-ignition and post-ignition may or may not causes knocking.
- Different type of combustion phenomenon available by this surface ignition are:
  1. Run-on surface ignition
  2. Run-away surface ignition
  3. Wild ping
  4. Rumble
- 1. **Run-on surface ignition:**
  - S. I. engine can be stop by switch-off the ignition system means power supply to spark plug is cut-off and hence spark does not occur by spark plug.
  - Theoretically engine should stop but actually it runs due to any hot surface (which may act as a spark plug) inside the engine cylinder. This phenomenon is known as “Run-on surface ignition”.
- 2. **Run-away surface ignition:**
  - Defective spark plug or exhaust valve receive the heat from combustion cycle and this heated spot causes pre-ignition. This type of surface ignition is very dangerous which may seizure or melt the piston and cylinder. The engine may catch fire, when fire enters in suction intake manifold.
- 3. **Wild ping:**
  - Some hot carbon deposits moves free inside the combustion chamber which provide source for combustion.
  - This combustion occurs erratic and unpredictable way produces very sharp knocking which is known as wild ping.
- 4. **Rumble:**
  - Due to hot spot inside the combustion chamber, combustion starts at a number of points (like diesel engine). It may be before (pre-ignition) or after (post-ignition) normal spark.
  - As combustion starts at number of points, heavy explosion of mixture take place which produces large erratic noise. High pressure waves produces resulting in engine vibration & noise which is known as engine rumble.

## 7.8. Effect of Engine Variables on Detonation in S.I. Engines

- It has been seen that the detonation in S.I. engine sets in if the end part of the gas auto-ignites before the flame front reaches it. The tendency to detonation will be reduced if the fuel has long ignition lag, high S.I.T. and high flame speeds or reduced time for flame travel. Therefore the onset of detonation is very dependent on the properties of fuel.
- Hence, those engine variables which tend to increase the ignition lag and increase the flame speeds would tend to reduce the detonation tendency. The factors are :
  1. **Intake temperature:**
    - Increased intake temperature reduces the delay period, therefore, increases the detonation tendency. However, it should be noted that the increased temperatures also increases the flame speed, thereby, reducing the detonation tendency.
    - But, the effect of increase temperature has more pronounced effect on delay period compared to flame speeds due to which the detonation tendency is increased with increase in intake temperature.
  2. **Intake pressure:**
    - Increased intake pressure increases the density of charge and reduces the delay period but increases the flame speed. The overall effect is to increase the detonation tendency.
  3. **Compression ratio:**
    - Increased compression ratio increases both the pressure and temperature and reduces the delay period, hence, the tendency to detonation increases.
  4. **Ignition advance:**
    - Advancing the spark timing increases the peak pressures of the cycle and thus reduces the delay period of end part of the gas in the combustion chamber, hence, tendency to detonate increases.
  5. **Coolant temperature:**
    - Raising the coolant temperature will increase the cylinder wall temperature and reduce the heat transfer rate between gas and cylinder walls.
    - Increased temperature of the gases would reduce the delay period and increase the detonation tendency.
  6. **Engine load:**
    - Higher loads on the engine increases the heating of the engine and reduces the delay period. Therefore the increased loads increases the detonation tendency of the engine.
    - It is for this reason the spark ignition engines are never overloaded.
  7. **Engine speed:**
    - Increase in engine speed increases the turbulence in the combustion chamber thereby increasing the flame speeds while the effect on the delay period is negligible. Due to this the increased speed of the engine reduces the detonation tendency.
  8. **Air-fuel ratio:**
    - It has been mentioned earlier that about 10% rich mixtures have the minimum delay period and the flame speeds are high.
    - But, it is observed that the effect of slightly rich mixtures on delay period is more dominant compared to flame speeds due to which the detonation tendency increases.

### 9. Engine size:

- Similar engines of various sizes have the delay period nearly the same. However, in case of larger sized engines the flame has to travel longer distance of combustion space compared to smaller sized engines.
- Therefore, the larger engines have more tendency to detonate compared to smaller engines.

### 10. Combustion chamber design:

- In general, more the compact combustion chambers, shorter will be flame travel and combustion time, hence, it will give better anti-knock characteristics.
- Also, if the combustion chamber design is such that it promotes turbulence then the flame speed will increase which would reduce the tendency to detonate.
- For above reasons the combustion chamber are designed nearer to spherical shape to reduce the distance of flame travel and shaped in such a way to promote turbulence

### 11. Location of spark plug:

- In case the spark plug is located centrally in the combustion chamber, it reduces the length of flame travel, hence, reduces the tendency to detonate. The flame travel can also be reduced by using two or more spark plugs.

### 12. Type of fuel:

- The fuels with lower self-ignition temperature or with its greater pre flame reactions will have more tendency to detonate.
- Fuels of paraffin series have maximum tendency to detonate and of aromatic series have minimum tendency to detonate.
- The naphthalene series fuels come in between the two.
- Table 7.1 gives the general summary of engine variables affecting the detonation in S.I. engines.

*Table 7. 1 Effect of engine variables on detonation in S.I. engines*

Sr. No.	Increase in variable	Effective on ignition lag	Effect on flame speed/on time factor	Overall tendency for engine to detonate
1.	Intake temperature	reduces	increases	increases
2.	Intake pressure	reduces	increases	increases
3.	Compression ratio	reduces	increases	increases
4.	Advancing ignition advance	reduces	negligible	increases
5.	Coolant temperature	reduces	slightly increases	increases
6.	Engine load	reduces	increases	increases
7.	Engine speed	negligible	increases	decreases
8.	Air-fuel ratio beyond 10% lean mixtures	increases	reduces	reduces
9.	Engine size	nil	time factor high	increases
10.	Turbulence	negligible	increases	reduces
11.	Distance of flame travel	negligible	increases	increases

## 7.9. Control of knocking

- Following are different parameter by which knocking tendency can be reduced.
  1. Increasing engine speed which increases the turbulence.
  2. Retarding spark timing.
  3. Reducing pressure in inlet manifold
  4. Using too lean or too rich mixture.
  5. Injecting the water inside the combustion chamber which reduces the in cylinder temperature, hence the knocking tendency decreases.
  6. Decreasing the compression ratio.
  7. Increasing turbulence by proper combustion chamber design.

## 7.10. S.I. engine Combustion Chamber Design

- Design of combustion chamber for S.I engine is very important for following reasons:
  1. To achieve high power output.
  2. To achieve high thermal efficiency.
  3. Smooth running of engine.
  4. To avoid knocking or detonation.
  5. Long life of engine.
  6. Minimum maintenance of engine.

### Objectives of Combustion Chamber Design for S.I. Engines

- A combustion chamber needs to be designed to meet the general objectives of developing high power output and high thermal efficiency with smooth running of engine and minimum octane number requirement of fuel. In order to achieve these objectives, following factors are to be kept in mind while designing the combustion chambers of S.I. engines.
  1. The **length of flame travel** from the spark plug to the farthest point should be kept minimum to avoid detonation problem.  
It involves the problem of location of spark plug and shape of combustion chamber. Usually the spark plugs are located at the central location or in some cases dual spark plugs are used.  
Also, the shape of combustion chambers should be as far as possible spherical to reduce the length of flame travel.
  2. To achieve **high speed of flame propagation**, an adequate amount of turbulence also ensures more homogeneous mixture by scouring away the layer of stagnant gas clinging to the chamber walls. However, excessive turbulence should be avoided since it increases the heat transfer losses to cylinder walls and affects the thermal efficiency of the engine.
  3. It should have small surface to volume ratio to minimise heat losses. A **hemispherical shape** provides minimum surface to volume ratio.
  4. It should provide large area to the inlet and exhaust valves with ample clearance around the valve head. It reduces the pressure drop across the valves, therefore, improves the volumetric efficiency. Use of sleeve valves are said to have low tendency to detonate compared to poppet valves due to absence of any high temperature area.
  5. Exhaust valves should not be located near the end gas location of combustion chamber to reduce the possibility of detonation since these valves are hottest spot in the combustion chamber.



6. The combustion chambers should be so designed that it can burn largest mass of the charge as soon as the ignition occurs with progressive reduction in the mass of charge burned towards the end of combustion.
7. Exhaust valve head is the hottest region of combustion chamber. It should be cooled by water jacket or by other means to reduce the possibility of detonation.
8. Octane number requirement of fuel increases with bore at the same piston speed when other factor remaining the same. Combustion time and cylinder inner surface temperature also increase with bore. For this reason the S.I. engine cylinder diameters are usually limited to 100 mm.
9. Thickness of cylinder walls should be uniform to avoid non-uniform expansion.

## 7.11. Different Types of Combustion Chambers for S.I. Engines in

### Use:

- Few important types of S.I. combustion chambers used are being discussed below :

#### 1. T-Head Combustion Chamber:

- This type of combustion chamber is shown in Fig. 7.11. It was used by Ford in 1908 but it is obsolete today. It has the following **disadvantages** :
  1. It needs two cam shafts to operate each valve separately.
  2. Long flame travel, therefore, it has more tendency to detonate. Compression ratios were limited to 5 : 1.
  3. Has high surface-volume ratio.

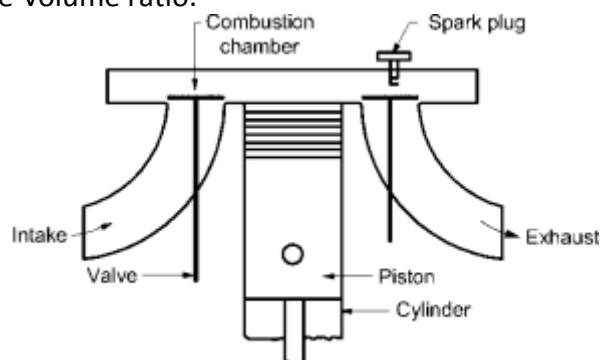

*Fig.7. 11 T-head combustion chambers*

#### 2. L-Head or Side Valve Combustion Chamber:

- Original form of L-head combustion chambers used up to 1930 is shown in Fig. 7.12. The top surface of the combustion chamber is in the form of a flat slab. Its intake valve and exhaust valve are kept side by side with spark plug location above the valves. Length of the combustion chamber covers the entire piston and valve assembly.
- **Advantages of L-head combustion chamber** :
  1. Easy to cast.
  2. Easy to carry out maintenance.
  3. Easy to lubricate the valve mechanism.
  4. Cylinder head can easily be removed, therefore, decarbonizing can be carried out without disturbing the valve gear mechanism.

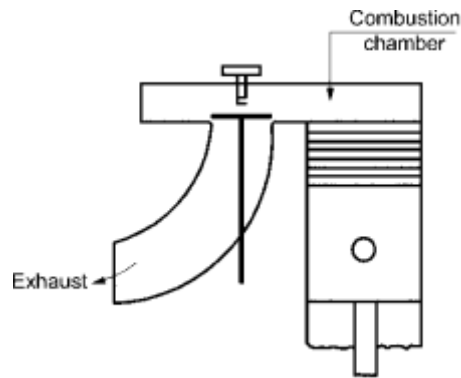
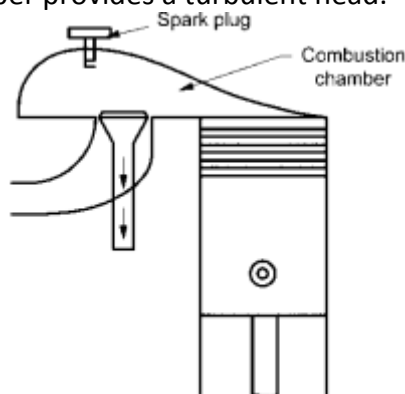

*Fig.7. 12 L-head combustion chamber*

- **Disadvantages of L-head combustion chamber :**
  1. There is a loss of velocity of intake air since it has to take two right angle turns before reaching the cylinder. It results into poor turbulence.
  2. Distance to be travelled by flame is more and it is super imposed by poor turbulence, therefore, tendency to detonation is more. Compression ratio is limited to 4 : 1.
  3. Mixing of air-fuel is unsatisfactory.
  4. It has low power and low thermal efficiency.

### **3. Recardo Turbulent Combustion Chamber:**

- The design of combustion chamber as suggested by Recardo in the year 1919 is shown in Fig. 7.13. However, modifications have been carried out in the design given at later stages.
- The Recardo combustion chamber overcomes the disadvantages experienced in the L-head combustion chamber.
- Recardo combustion chamber provides a turbulent head.



*Fig.7. 13 Recardo turbulent combustion chamber*

- The salient features of this combustion chamber are :
  1. Combustion chamber provides high turbulence. Because at top dead centre position only a thin layer of charge exists between the piston crown and combustion chamber, due to this the whole charge is pushed back in the combustion chamber during the compression stroke, therefore, it provides additional turbulence.
  2. Combustion chamber ensures a more homogeneous mixture of fuel and air by scouring away the layer of stagnant gas clinging to the chamber walls.
  3. The piston comes in closed contact with the combustion chamber head in this design, it reduces the effective length of flame travel. Hence, tendency to detonation is reduced.

4. Because of contact of piston with chamber the mass of end gas is negligible. Therefore impact of detonation will be negligible even if detonation occurs.
5. The detonation tendency is further reduced since the end gas is a thin layer and it is cooled by comparatively cooler cylinder head.
6. Spark plug is centrally located in the combustion chamber, the length of flame travel is reduced. It results into reduced tendency to detonate.

### **Modern S.I. Engine Combustion Chambers:**

- After the period of 1950 the combustion chambers used are either overhead valve, also called as I-head, combustion chambers or the F-head combustion chambers. Overhead combustion chambers were first introduced in Ambassador Car in the year 1959.
- The overhead and F-combustion chamber designs are based on principles of Ricardo combustion chamber with certain modifications.
- The advantages of overhead valve combustion chambers on L-head combustion chambers are as follows :
  1. Use of large valves or valve lifts and reduced passage ways provides better breathing of the engine, it increases volumetric efficiency of the engine with reduced pumping losses.
  2. It gives less tendency to detonate due to reduced flame travel.
  3. Less force on head bolts and reduced possibility of leakage.
  4. Exhaust valve is incorporated in the combustion chamber head instead of cylinder block. Therefore, heat failures limited to head only.
  5. Uses low surface-volume ratio, it reduces the heat losses and increases power output and efficiency.
- Few of the important combustion chambers of overhead valve type and F-head type are described below.

#### **1. Bath Tub Combustion Chamber:**

- This type of combustion chamber is shown in Fig. 7.14. It is simple and easy to cast. Both valves are mounted on the head with spark plug on one side of the combustion chamber.
- The charge at the end of compression stroke is pushed into the combustion space known as squish which provides additional turbulence.
- Since the valves are provided in a single row in the head, it reduces the size of the valves.
- Because of this the disadvantage of this design is that it reduces the breathing capacity of the engine with increased pumping losses.
- To overcome this difficulty, the modern engine design use relatively larger piston diameters compared to stroke length.

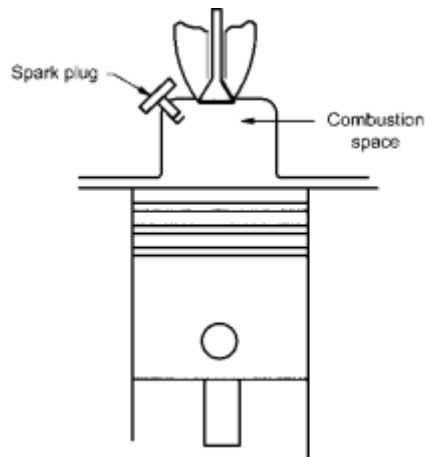

*Fig.7. 14 Bath tub combustion chamber*

## 2. Rover Head Combustion Chamber:

- The piston has cavity at the centre which produces high turbulence and reduces knocking tendency.
- High compression ratio can be used
- Due to high CR better combustion with high thermal efficiency can be achieved

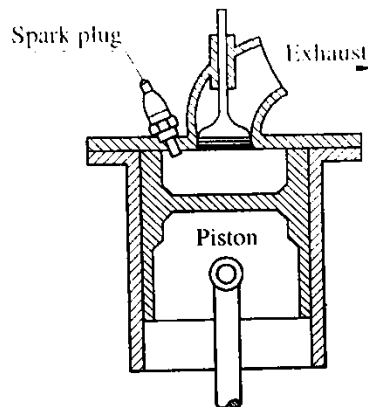

*Fig.7. 15 Rover Head Combustion Chamber*

## 3. Wedge Head Combustion Chamber:

- This type of combustion chamber is shown in Fig. 7.16. Valves are placed in inclined position.
- The end gas is kept cool by the intake valve and relatively cooler piston.
- Spark plug is approximately kept at the centre and it reduces the flame travel.

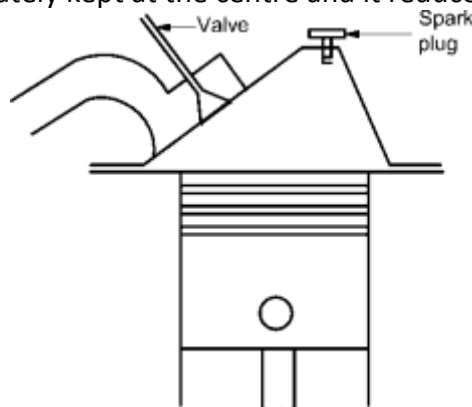

*Fig.7. 16 Wedge head combustion chamber*

#### 4. F-Head Combustion Chamber:

- Fig. 7.17 shows the combustion chamber similar to combustion chamber used by Willy's Jeep in India. This combustion chamber is also wedge shaped but similar in design to Rover head chamber.
- This combustion chamber has all the advantages of modern combustion chambers listed above. The inlet valve is kept in vertical position with large intake area to increase breathing of air and reduce the pumping losses.
- The air during compression stroke creates turbulence due to back flow of air into the chamber.
- Additional turbulence is created by the left hand portion of the piston head when at TDC by squish action.

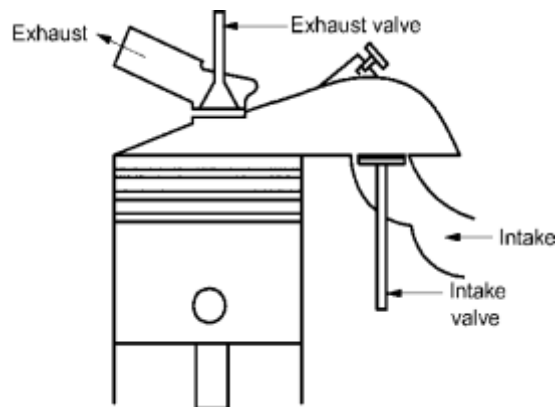
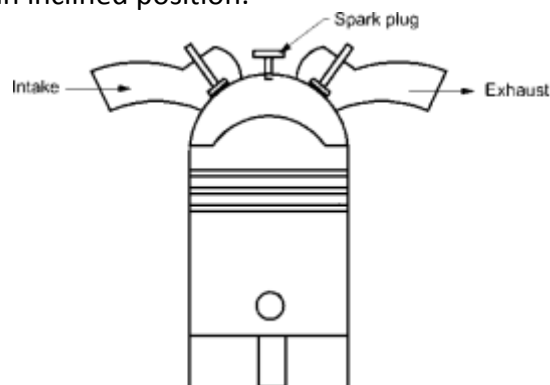

*Fig.7. 17 F-head combustion chamber*

- The spark plug is inclined and so located that it reduces the flame travel, hence, the detonation tendency.

#### 5. Combustion Chamber for Jaguar Engine:

- Fig. 7.18 shows the combustion chamber shape used for Jaguar engine.
- It utilises the principle that the hemispherical shape gives the minimum surface to volume ratio.
- Such a concept is useful to reduce the head losses thereby increasing the output power and thermal efficiency of the engine.
- The combustion chamber is designed hemispherical shape with inlet and exhaust valves placed on the sides of the head.
- Valves are operated in inclined position.



*Fig.7. 18 Combustion chamber to Jaguar engine*

- Hemispherical shape used not only reduces the heat transfer losses by virtue of low surface to volume ratio, it also permits to use the larger diameter valves, therefore, has higher volumetric efficiency.
- The crown of piston is so shaped to produce required turbulence, therefore, the flame speeds are increased, hence, reduces the tendency to detonate.
- Spark plug is located centrally which reduces the flame travel and again it helps in preventing detonation.

## **Section II: Combustion in C.I. Engines**

### **7.12. Introduction**

- C.I. engine only air sucks during suction and fuel is injected at the end of compression stroke.
- In S.I. engine nearly stoichiometric air fuel mixture is supplied while in C.I. engine 40 to 75% excess air is required for better combustion. For induction of this excess air, the size of C.I. engine compared to S.I. engine is always larger and heavier to generate the 1 same power.
- C.I. engine the combustion starts at 1 number of points simultaneously i.e. multipoint combustion takes place.
- In S.I. engine combustion takes place due to spark, whereas in C.I. engine combustion takes place due to compression ignition. As self-ignition temperature (SIT) of diesel is low, fuel can be ignited without spark.
- During compression stroke only air is compressed to higher pressure (CR = 16 to 22), so that temperature of air inside the cylinder increases (440 to 540°C) beyond SIT of diesel fuel. At the end of compression, diesel fuel is injected in liquid state at very high pressure (120 to 200 bar) with the help of fuel pump and injector.
- The atomized fuel vaporize, mix with air, and combustion starts.

### **7.13. Combustion Stages in C.I. Engines**

- In case of compression ignition engines the air alone is compressed and raised to high pressure and temperatures in the compression stroke by using high compression ratios.
- The temperature of air attained is far above the self-ignition temperature of the diesel fuel used.

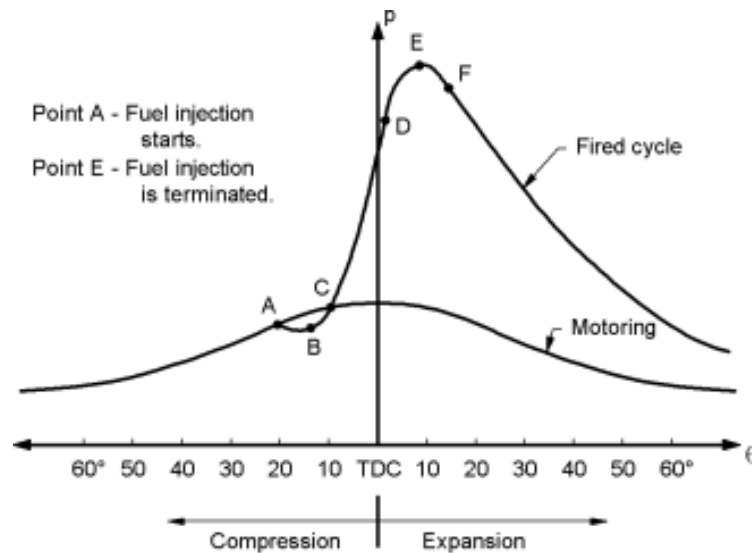

Fig.7. 19 Combustion stages in C.I. Engines

- The fuel is injected by a fuel pump into the combustion chamber by one or more jets under very high pressures of about 120-210 bar pressures at about (20°– 35°) before TDC. The point A represents the time at which the fuel injection starts on (p - θ) diagram shown in Fig. 7.19. Combustion takes place in four stages which are as follows :

### 1. First stage (Ignition delay period):

- The fuel leaves the nozzles initially in the form of a jet, and later on, it disintegrates into a core of fuel surrounded by a spray envelope of air and fuel particles due to atomization, vaporization and mixing with hot air.
- During vaporization process of fuel it receives its latent heat from surrounding air and this causes a slight drop in pressure in the cylinder as shown by curve AB.
- As soon as the vaporization is over, the preflame reactions of the mixture start. During such chemical reactions the energy is released at slow rate and the pressure starts building up.
- Therefore, the preflame reactions first start slowly and then accelerates until the ignition of fuel takes place. It corresponds to point C on diagram.
- The time interval between the start of fuel injection and commencement of combustion is called the **delay period**.
- The delay period can be divided into two parts as follows :

#### a) Physical delay:

- This represents the time interval from the time of injection of fuel to its attainment of self-ignition temperature during which the fuel is atomized, vaporized and mixed with air.

#### b) Chemical delay:

- After physical delay period is over, the time interval up to the time the fuel auto-ignites and flame appears is called chemical delay.
- During this period pre flame reactions take place. This period corresponds to ignition lag of S.I. engines.

- In practice, it is very difficult to separate exactly these two delay periods since the processes involved are very complex.

## **2. Second stage (Period of uncontrolled combustion):**

- Once the delay period is over the mixture of fuel and air will auto-ignite since it is above the self-ignition temperature.
- The flame appears at one or more locations where concentration of fuel and air mixture is optimum. This is due to the fact that the mixture present in the combustion chamber at the time of ignition is extremely heterogeneous unlike the homogeneous mixture of S.I. engines.
- Once the flame appears the mixture in other regions will either be burnt by propagating flames or it will auto-ignite because of the heat transfer from the burnt mixture and high temperatures existing in the combustion chamber.
- The fuel which is accumulated during the delay period is now ready for combustion and it would burn at an extremely rapid rate causing a steep rise in cylinder pressure and temperature.
- The rate of pressure rise depends upon the fuel injected and accumulated, which is directly proportional to the time of injection and the engine speed.
- Higher the delay period, higher would be the rate of pressure rise. During this period it is difficult to control the amount of fuel burning, for this reason, this period of rapid combustion is called the period of uncontrolled combustion as represented by curve CD in Fig. 7.19.

## **3. Third stage (Period of controlled combustion):**

- Once the fuel accumulated during the delay period is burnt in the period of uncontrolled combustion, the temperature and pressures in the cylinder will be so high that the further quantity of fuel injected will burn as soon as it leaves the nozzle provided sufficient oxygen is present in the cylinder.
- Therefore the rate of pressure rise can now be controlled by controlling the rate of fuel injection. This period of combustion is known as period of controlled combustion represented by curve DE.

## **4. Fourth state (After burning):**

- Theoretically the combustion is completed at the point the maximum pressure is attained during the cycle corresponding to point E few degree after TDC.
- However, the burning of fuel continues during its expansion stroke due to reassociation of dissociated gases and any unburned fuel due to heterogeneous condition of mixture. This phase of combustion is called after burning.

## **7.14. Effect of Engine Variables on Delay Period**

### **1. Compression ratio:**

- Increased compression ratio increases the density, pressure and temperature of the charge. Increased temperatures and pressure reduces the delay period.

### **2. Inlet pressure (supercharging):**

- Increased inlet pressures increases the pressures in the compression stroke and reduces the delay period.



### 3. Intake temperature:

- Higher intake temperatures will result into high temperatures at the time of fuel injection, therefore, it will reduce the delay period.

### 4. Engine speed:

- Increased speed will increase the delay period in terms of degrees of crank rotation, since the fuel pump is driven by the engine through gears. Therefore, during the delay period more fuel will be accumulated in the cylinder with increased speed and burning of this fuel during the period of uncontrolled combustion will result into high rate of pressure rise and high temperatures. It also results into better mixing of fuel and air due to increased turbulence.

### 5. Jacket water temperature:

- Increased jacket water temperature increases the air temperature in the cylinder, hence, reduces the delay period.

### 6. Load on engine:

- Increased loads on the engine reduces delay period. Since the air-fuel ratio decreases with the increase in operating temperatures.

### 7. Injection pressure:

- Increased injection pressures will give better atomization of fuel. It generally tends to reduce the delay period slightly.

### 8. Fuels:

- Higher the self-ignition temperature of the fuel, higher will be the delay period.

### 9. Injection timing:

- If fuel is injected much before TDC the delay period is larger since the pressure and temperatures in the cylinder are low. It will give extremely high rate of pressure rise during the period of uncontrolled combustion.
- Too late injection will reduce delay period but it would result in poor efficiency of the engine and the engine will not run smoothly.

### 10. Engine size:

- It has no effect on delay period in terms of time. However, large engines operate at lesser speed, therefore, delay period in terms of crank angle is smaller. Hence, less fuel enters the cylinder and the engine will run smooth.

## **7.15. Knock in C.I. Engines (Abnormal Combustion)**

- In C.I engine as delay period increases, the amount of fuel injected and accumulated in combustion chamber increases. A very high temperature and pressure is generated by combustion of this large amount of fuel is known as knocking or detonation in C.I engine.
- “Accumulation of fuel during large delay period creates very high pressure, it is known as knocking in C.I. engine.”
- This high rate of pressure rise creates pulsating combustion which produces heavy noise.
- In C.I. engine knocking occurs during initial phase of combustion i.e. as delay period is completed and uncontrolled combustion starts.

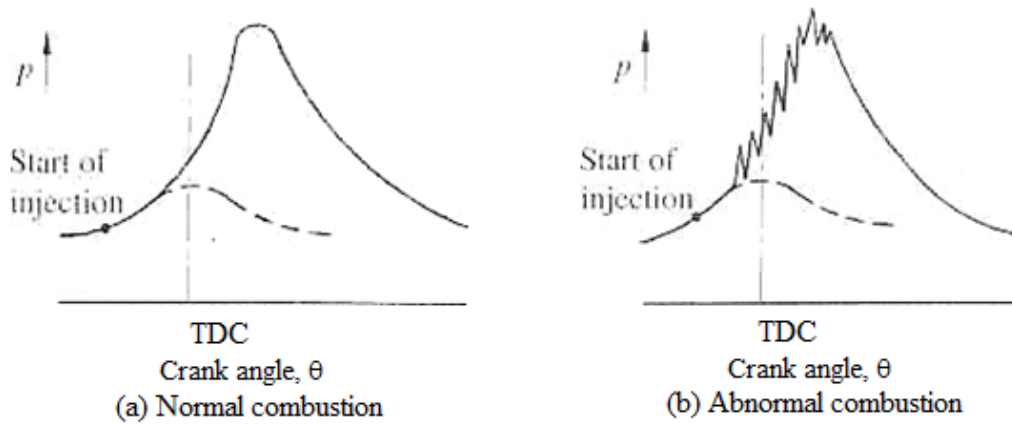

Fig.7. 20  $p - \theta$  diagram of C.I. engine with and without Knocking

## 7.16. Factors affecting the knocking in C.I engine

Table 7. 2 Factors affecting the knocking in C.I engine

Sr. No	Variable increases	Effect on knocking tendency
1.	Fuel (Cetane No.)	Decreases
2.	Intake air/fuel/Jacket water temp.	Decreases
3.	Intake Pressure (supercharging)	Decreases
4.	Load (F: A Ratio)	Decreases
5.	Injection pressure	Decreases
6.	Injection advance angle	Increases
7.	Engine size	Decreases
8.	Speed	Increases
9.	Compression ratio	Decreases

## 7.17. Comparison of the knocking in S.I. and C.I. engines

- (1) In S.I. engine knocking takes place at the end of combustion process while in C.I. engine it takes place at the beginning of combustion.
- (2) In S.I. engine knocking is due to end charge auto-ignition before reaching the flame while in C.I. engine knocking is due to auto-ignition of more fuel accumulated due to long delay period.

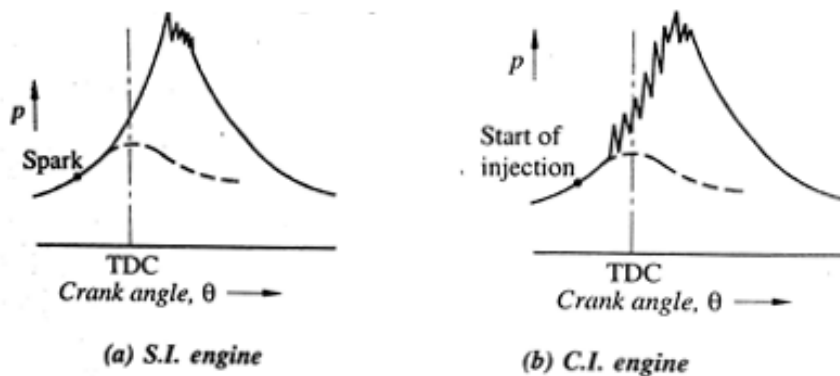

Fig.7. 21  $p - \theta$  diagram of S.I and C.I. engine

- (3) In S.I. engine pressure rise is very high during knocking due to homogeneous mixture as compared to the C.I. engines.

- (4) Chances of pre-ignition in the S.I. engine is more because air-fuel mixture enters during suction stroke while in the C.I. engine fuel is injected at the end of compression stroke.
- (5) In the C.I engine knocking is due to delay period and delay period cannot be zero. There is always pressure rise due to accumulation of fuel during delay period. Therefore, the C.I. engine is known as knock engine. As degree of pressure rise increases above certain limit which may start to produce audible noise and vibration. It is the starting of knocking. Therefore, in the C.I. engine it is difficult to distinguish between knocking and non-knocking operation.
- Table 7.3 gives the factors which reduce the detonation and knocking tendency in S.I. and C.I. engines.

*Table 7.3 Factors tending to reduce detonation and knocking in S.I. and C.I. engines*

Sr. No.	Factors	S.I. engine	C.I. engine
1.	Compression ratio	low	high
2.	Inlet temperatures	low	high
3.	Inlet pressures (super charging)	low	high
4.	Self ignition temperature of fuel	high	low
5.	Time lag or delay period of fuel	long	short
6.	Load on the engine	low	high
7.	Combustion wall temperature	low	high
8.	Speed (rpm)	high	low
9.	Cylinder size	small	large

## 7.18. Combustion Chamber Design for C.I. Engines

### Objectives

- In the C.I engine during induction, suction, and compression only air is there and fuel is injected at the end of compression. The time available for vaporization and mixing with air is very limited. Also for better mixing and better combustion air swirl is required which gives better combustion.
- For better combustion atomization, vaporization and proper mixing with air is required in minimum time and result of all these give high power, better efficiency, smooth and noiseless engine running, and shorter delay period which reduces probability of knocking.
- To achieve all of the above advantages the design of C.I engine combustion chamber becomes more complicated and swirl is very important in the C.I engine.

### Air Swirl:

- For proper mixing of fuel and air in the combustion chamber the various methods of air movement are employed called **air swirl**. Various types of air swirl are being discussed below :

#### 1. Induction Swirl

- In this method swirl is provided to incoming air to the cylinder during suction, that's why it is known as induction swirl.
- Different methods of giving swirl to incoming air are shown in fig 7.22 in which air enters at some angle and gets the swirl.
- Fig. 7.22 (b) shows a masking or shrouding one side of the inlet valve, so that air enters only around the part of periphery of the valve and air swirl is produced. The angle of mask used usually varies from  $90^\circ$  to  $140^\circ$ .
- The best tangential direction of air movement can be obtained by turning the valve around its axis. Fig. 7.22 (c) illustrates the method of producing air swirl by casting a lip on one side of the inlet valve. Air enters from the top and due to lip it gets the swirl.

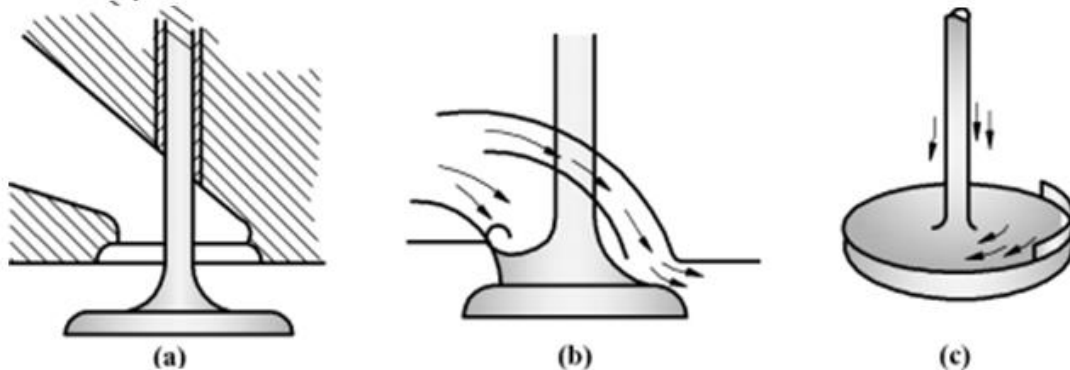

Fig.7. 22 Different methods of achieve induction swirl

## 2. Compression Swirl

- In this method air swirl is produced during compression stroke. At the top of the piston different types of cavity is formed which gives different type of swirl during compression. It is shown in Fig. 7.23 (a) and (b).

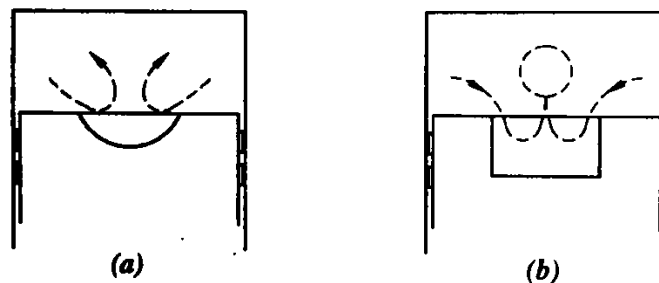

Fig.7. 23 Compression Swirl

## 3. Combustion Induced Swirl

- In this method swirl is produced by high pressure generated during first part of combustion of fuel. The piston head have different types of design which help to generate the swirl during combustion. This method is employed in pre-combustion and air cell combustion chamber designs.

### 7.19. Classification of Combustion Chambers for C.I. Engines

- The combustion chamber for the C.I. engines are classified as follows:
  - a. Open combustion chamber or Direct injection (D.I.) combustion chambers.
  - b. Pre-combustion chamber.
  - c. Turbulent combustion chamber or Indirect injection combustion chamber.
  - d. Special combustion chambers.

#### 1. Open or Direct Injection (DI) Combustion Chambers

- In an open combustion chamber the space between the piston and cylinder head is open i.e. no restriction in between. Therefore, all air is contained in single space between the piston and cylinder head. The fuel is directly injected inside this space that's why it is also known as direct injection engine or in short D.I. engine.
- To achieve better combustion and swirl different types of cavity are formed in piston crown and cylinder head.
- In some cases, the shape of cylinder head provides a cavity to create favourable conditions for better mixing and better burning.
- The salient features of open combustion chamber are:
  - (1) Less turbulence is generated in this type, so heat loss is less and thus, starting is easier.
  - (2) Excess air required is more, so engine size increases, and thermal efficiency also increases.
  - (3) Generally they are used for large capacity, and low speed engines.

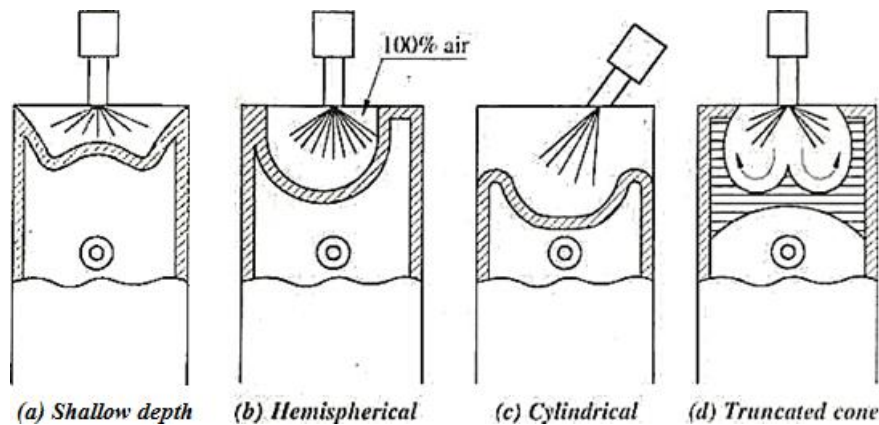

Fig.7. 24 Cavity in piston crown

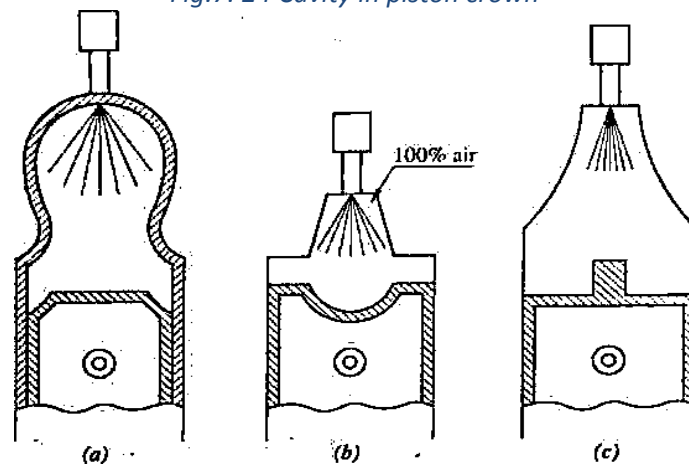

Fig.7. 25 Cavity in piston crown

- Advantages and disadvantages of this type of combustion chambers are as follows :

**Advantages:**

1. The thermal efficiency is high because heat transfer losses are less.
2. Easier starting because heat transfer losses are less.
3. Simple in construction.
4. In case of slow speed engines less costly fuels with longer delay can be used.

Disadvantages:

1. Engine size becomes large for generating same power due to large excess air required.
2. Due to less turbulence, high injection pressure is required with multiple hole nozzle.
3. Maintenance cost is higher.

## 2. Pre-Combustion Chamber

- A small additional chamber called as pre-combustion chamber is connected with main combustion chamber where fuel is injected in this pre-combustion chamber. Both these chambers are connected with small holes.
- As fuel is injected, combustion starts at pre-combustion chamber and products of combustion rush out through small holes to main combustion chamber with very high velocity, thus it generates turbulence as well as swirl which produces bulk combustion in the main combustion chamber. About 80% of energy is released in main combustion chamber.
- The first combustion starts at pre-combustion chamber due to high temperature of it and it propagates to main combustion chamber, thus the delay period is reduced and poor grade fuel can also be easily burnt.

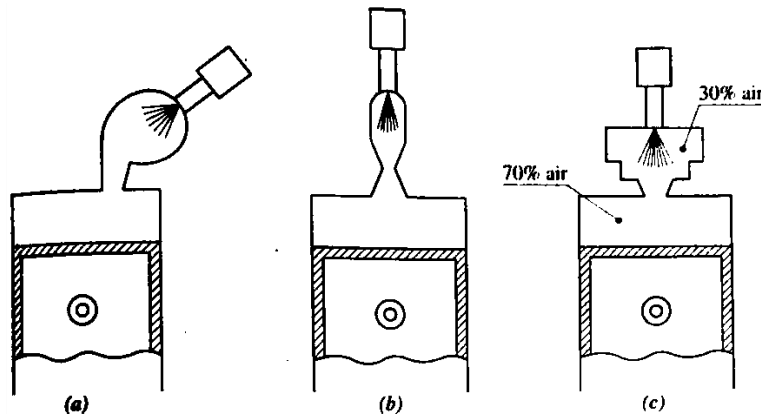

*Fig.7. 26 Precombustion chamber*

Advantages:

1. Fuel with wide range of Cetane No. can be used.
2. As injection pressure is low, simple fuel nozzle can be used.
3. Smoother running of engine.
4. Engine can be run at high speed.
5. As delay period in main combustion chamber is very small, knocking tendency is very less. Also engine can run with higher compression ratio.

Disadvantages:

1. Engine design becomes complicated due to pre-combustion chamber.
2. Heat loss from pre-combustion chamber is high.
3. Due to high heat loss cold starting is difficult.
4. The fuel consumption is high and thermal efficiency is low.

### 3. Turbulent or Indirect Injection (IDI) Combustion Chambers

- These combustion chambers are similar as that of pre-combustion chamber. The difference is that in pre-combustion chamber only 20 to 25% of total air enters while in these type 80 to 90% of total air circulates in pre-chamber.
- As high rate of “swirl” produces in this type, it is also known as swirl combustion chamber. During compression stroke most of the air from main combustion chamber enters to pre-combustion chamber, where high rate of swirl is produced.
- Fuel is injected in this pre-combustion chamber and the ignition and bulk of the combustion takes place therein. Few configurations of these type are shown in Fig.7.27 (a) and (b).

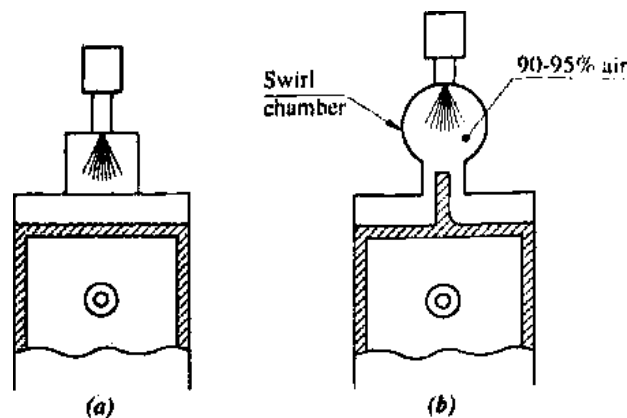

Fig.7. 27 Turbulent or Indirect Injection (IDI) Combustion Chambers

- The advantages and disadvantages of this type are listed below:

Advantages:

1. Due to high rate of swirl comparatively rich mixture (low A:F ratio) can be used which makes engine compact for given output.
2. Large range of Cetane No. fuel can be used.
3. Injection pressure and pattern of injection is not very important due to swirl f thus simple nozzle can be used.
4. Smooth running and low maintenance of the engine.
5. The engine can be operated at high speed because delay period is very small, thus probability of knocking is less.

Disadvantages:

1. Due to large heat loss to cylinder wall fuel consumption increases (high bsfc).
2. Low thermal efficiency due to heat loss.
3. Cold starting of engine is difficult.

### 4. Special combustion chambers

#### 1. M.A.N. Combustion Chamber

- Dr. Meurer of Maschinenfabric Augsburg Nurnberg (M.A.N.) of Germany in 1954 developed a special type of open combustion chamber, also called as 'M' combustion chamber.
- It is suitable for small, high speed engines. In this design, the combustion chamber has a spherical cavity in the piston as shown in Fig. 7.28.
- The fuel spray impinges tangentially on the cavity and it spreads over the entire chamber. Such type fuel spray impingement was believed to be undesirable in earlier designs of open combustion chambers.

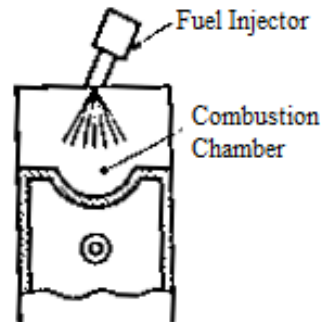

*Fig.7. 28 M.A.N. combustion chamber*

- But according to the theory used in this design it is suggested that the air borne fuel spray in the cavity makes homogeneous mixture and it auto ignites before impingement with normal delay period, while the remainder fuel impinging on the cavity walls have to evaporate from the cavity prior to combustion.
- It controls the rate of pressure rise in the second stage of combustion and gives smooth running of engine.
- However, it is further possible to control the air borne fuel spray by varying the distance between the nozzle tip and the combustion chamber walls.

#### Advantages:

1. Large range of fuel can be used, so poor quality of fuel with low cetane no. can also be used.
2. Better combustion and low exhaust emission.
3. More power because of high volumetric efficiency.
4. Easy cold starting.
5. No combustion noise.
6. Low rate of pressure rise.

#### Disadvantages:

1. Poor performance and high emission at low load on engine.



## 2. Air-Cell Combustion Chamber

- Air-cell combustion chamber design used for Lanova engine is represented in Fig. 7.29. In this case a separate air-cell through a small neck communicates with the main combustion chamber.
- The fuel is injected across the main chamber into the neck of air-cell which is designed to run hot.

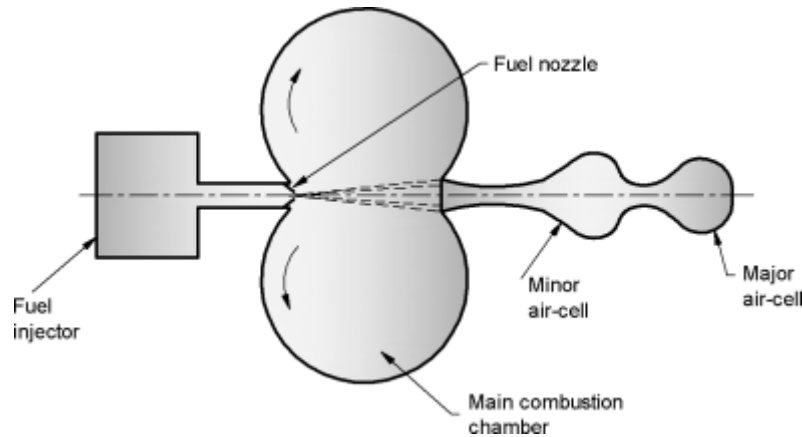

*Fig.7. 29 Air cell combustion chamber for Lanova engine (plan view)*

- The combustion is initiated in the air cell and due to high pressure rise it flows back into main chamber.
- The main combustion chamber is so designed that the gas stream from air-cell splits into two vertices to create high swirl.
- High turbulence and high temperature of gases reduce the delay period and it controls the rate of pressure rise and the engine runs smooth.
- This design differs from pre-combustion chamber in respect of fuel injection.
- In case of air cell the fuel is injected in the main chamber while in the other case into pre-combustion chamber.

### Advantages:

1. Cold starting of the engine is easier.
2. Due to high rate of swirl better mixing of air and fuel can be achieved which improves the combustion.
3. Exhaust emissions is less.
4. As maximum pressure rise is low, engine runs smoothly.

### Disadvantages:

1. Low thermal efficiency.
2. Higher fuel consumption (high bsfc).
3. Cannot be used for variable speed engine.

## Tutorial Questions

1	State and explain different combustion stages in SI engine?
2	State and explain different combustion stages in CI engine?
3	Explain knocking, properties and its effects in CI engine?
4	Explain different types of combustion chambers in SI and CI engines?
5	Explain the need for air motion and types?
6	Factors influencing knocking in SI and CI engine?
7	Differentiate between normal combustion and abnormal combustion phenomena in case of SI Engine.
8	What is the importance of variables like flame speed flame front in case of delay period.
9	Explain knocking additives.
10	Discuss air flow movements in CI engines

## Assignment Questions

1	Explain the Splash lubrication system with the diagram?
2	Explain the carburetor working principle with diagram?
3	What are the types of fuel injection systems? Explain any one with a neat sketch?
4	How to tell a two stroke cycle engine from a 4 stroke cycle engine?
5	Explain the Pressure feed system with a diagram?