

## UNIT - 1

### Introduction:

Instrumentation is a technology of measurement which serves not only science but all branches of engineering, medicine etc.

→ Measuring is basically used to monitor (or) control a process. Ex: Thermometers, barometers, anemometers used to indicate environmental conditions. Similarly water, gas & electric meters are used to monitor the quantity used.

→ The major problem with any measuring instrument is Error.

→ The basic concern of any measuring instrument is it should not affect the quantity being measured.

→ Any instrument basically consists of three stages.

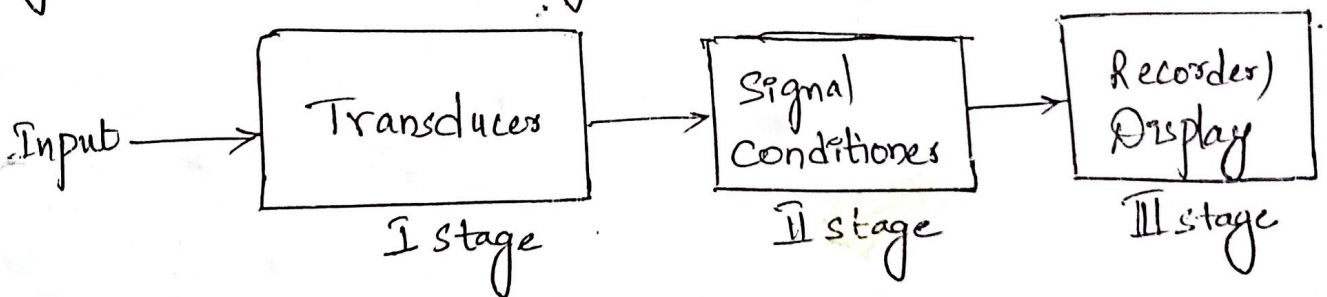

I stage: Transducer: It is a device activated by an energising input from one (or) more transmission media and generates an appropriate signal in different form to one (or) more transmission systems. The input may be electrical, mechanical (or) acoustical. The output may be analog, digital (or) frequency modulated.

"It is a device that converts one form of energy into another form"  
The converted electrical (or) mechanical signal is given as input to second stage i.e. Signal Conditioner. Ex: Photo detector, Strain gauge etc.



## Stage-II : Signal conditioners:

The output of the first stage has to be modified before it be-  
usable to the signal indicating stage. A signal conditioner  
equipment has to perform linear processes such as amplification,  
attenuation, Integration, Differentiation, addition (or) subtraction.  
There are also some non-linear processes such as modulation,  
demodulation, sampling, filtering, clipping, clamping etc. Transducer's  
output is brought to the required level to make it useful  
for conversion, processing, indicating and recording ex: opamp, modulator etc

## Stage-III :

The measuring instruments quantity is displayed (or) recorded  
in this stage

Recorder: It is a measuring instrument that displays a time-varying  
signal, even after the original signal does not exist.  
ex: potentiometer recorders, null type recorders, X-Y recorders etc

Display (or) Indicator: The essential requirement of an indicator is  
to display the data in a readily understandable form. They provide  
visual display of numbers, letters and symbols in response to the  
given input.

## Performance characteristics:

⇒ A knowledge of performance characteristics of an instrument  
is essential for selecting most suitable instrument for specific measure.  
The performance characteristics of any measuring devices are of two types.

1. Static characteristics.
2. Dynamic characteristics.



Static Characteristics of Instrument: These are the characteristics that are used to determine present value of the quantity under measurement. Static characteristics are:

- (1) precision
- (2) Expected value
- (3) Error
- (4) Accuracy
- (5) Resolution
- (6) Sensitivity

(1) precision:

It is the measure of consistency (or) repeatability of measurements i.e successive readings do not differ. (precision is the consistency of the instrument output for a given value of input) ex-  $\pi = 3.14$  is correct value (or) true value and it is accurate but  $\pi = 3.1428574$  is precise as well as accurate value.  $\pi = 3.2428574$  is precise but not accurate.

(2) Expected value:

It is the design value i.e the most probable value that calculations indicate one should expect to measure. ex- voltage is measured then the value expected is in  $\mu\text{V}$ ,  $\text{mV}$  (or)  $\text{V}$  (volts) or 100's of volts etc.

(3) Errors:

The deviation of the true value from the desired value is called an Error. when the measured value exceeds the true value the error is said to be positive else negative. By minimizing error accuracy can be increased.

(4) Accuracy:

The degree of exactness (or closeness) of measurement compared to expected (desired) value.



The accuracy of the whole system depends upon the accuracy of individual instruments of that system. Ex: If  $A = \pm 1\%$  for 100V voltmeter then the maximum error for any reading will not exceed  $\pm 1V$ .

(5) Resolution:

The smallest change in a measured variable to which an instrument will respond. Ex: A 100V voltmeter may not be able to measure 100mV. Only for minimum input of 0.5V the needle deflects. Hence resolution of that instrument is of 0.5V.

(6) Sensitivity:

The ratio of change in output (response) of the instrument to a change of input or measured variable. Its units are mm/ $\mu A$  (or) mm/ $\Omega$  (or) counts per volt etc

$$\text{Sensitivity} = \frac{\text{change of output}}{\text{change of input}}$$

$$\text{Deflection factor} = \frac{1}{\text{Sensitivity}}$$

Difference between accuracy and precision:

→ Accuracy and precision depends upon systematic and random errors.

→ An accurate measurement might not be precise vice-versa.

→ For example consider game of darts, when one is asked to strike the target by center circle. The center circle represents true value and the result achieved by the strikes has been indicated "x".

Ex: 1

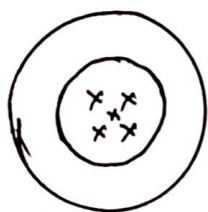

(a) High Accuracy  
High precision

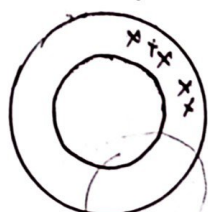

(b) Low accuracy  
High precision

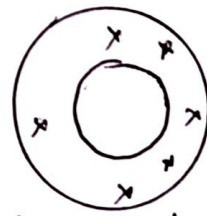

(c) Low Accuracy  
Low precision

EX: 2: Precise but not accurate

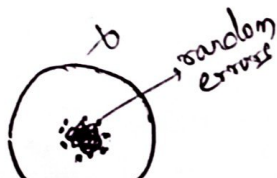
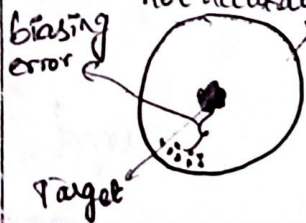

Accurate but not precise



not precise & not accurate



Precise & accurate

An instrument → should have high accuracy & high precision



## Error In measurement:

The most important static characteristics of an instrument is its accuracy, which is generally expressed in terms of the error called static error.

"It is the algebraic difference between the true value (expected value) and the indicated value of the quantity to be measured is called an error." It is denoted as 'e'.

$$e = A_t - A_m$$

e → error

$A_t$  → True value of quantity

$A_m$  → measured value of quantity

$$\% \text{ of error} = (A_t - A_m) \times 100$$

$$\text{Relative error } e_r = \frac{\text{Absolute error}}{\text{True value}} = \frac{\text{True value} - \text{measured value}}{\text{True value}}$$

$$e_r = \frac{A_t - A_m}{A_t}$$

$$\% e_r = \left( \frac{A_t - A_m}{A_t} \right) \times 100$$

The accuracy can be mathematically expressed as

$$A = 1 - e_r$$

A → Relative accuracy

$$A = 1 - \left| \frac{A_t - A_m}{A_t} \right|$$

$$a = A \times 100\%$$

a → Percentage accuracy

Ex: Expected value of the voltage across a resistor is 80V. However, the measurement gives a value of 79V. Calculate (i) Absolute error, (ii) % error (iii) relative accuracy and (iv) % accuracy (v) Error in FS if scale ranges for 0-200V.

i) Absolute error =  $A_t - A_m = 80 - 79 = 1V //$

ii) % error =  $\frac{A_t - A_m}{A_t} \times 100 = \frac{80 - 79}{80} \times 100 = 1.25\% //$

iii) Relative accuracy  $A = 1 - \left| \frac{A_t - A_m}{A_t} \right| = 1 - \left| \frac{80 - 79}{80} \right| = 0.9875 //$



(iv) % of accuracy  $a = 100 \times A$   
 $= 100 \times 0.9875$   
 $a = 98.75\%$

(v) % of error expressed as % of full scale reading is,  
 $= \frac{A_t - A_m}{f.s.d} \times 100$   
 $= \frac{1}{200} \times 100$   
 $= 0.5\%$

→ Precision is expressed mathematically as

$$P = 1 - \left| \frac{x_n - \bar{x}_n}{\bar{x}_n} \right|$$

$x_n \rightarrow$  value of  $n^{\text{th}}$  measurement  
 $\bar{x}_n \rightarrow$  average set of measurement

Ex: The table shows set of 5 measurements recorded in a lab. Calculate precision of 3rd measurement.

Sol:  $\bar{x}_n = \frac{\text{Sum of readings}}{\text{no. of readings}} = \frac{251}{5} = 50.2$

The value of 3rd measurement is  $x_n = 52$

where  $n=3$  :  $P = 1 - \left| \frac{x_n - \bar{x}_n}{\bar{x}_n} \right|$   
 $P = 1 - \left| \frac{52 - 50.2}{50.2} \right|$

$P = 0.964$  (or)  $96.4\%$

Measurement number	Measurement value $x_n$
1	49
2	51
3	52
4	50
5	49

Types of Static Errors: Generally they are classified as,

- (1) Gross errors (Human errors)
- (2) Systematic errors (biasing errors) and
- (3) Random (or) accidental errors



(1) Random Errors:

- Human mistakes in reading (or) using instruments and in recording and calculating measurement results.
- These errors may occur due to computational mistakes.
- It is not possible to eliminate these errors but they can be minimized by
  - (i) Special attention should be taken in reading and recording the data.
  - (ii) The experimenter should not depend on only one reading, at least three (or) even more readings must be taken

(2) Systematic Errors: (biasing errors)

- These errors occur due to shortcomings of the instrument, such as defective (or) worn parts (or) ageing (or) effects of the environment on the instrument.
- A constant uniform deviation of the operation of an instrument is known as systematic errors.
- There are basically three types:
  - (i) Instrumental errors
  - (ii) Environmental errors
  - (iii) Observational errors

(i) Instrumental Errors:

- Instrumental errors are inherent in measuring instruments, because of their mechanical structure.
- For example D'Arsonval movement, friction in bearings of different components, irregular spring tensions, stretching of the spring (or) overloading of the instrument.



Instrument errors can be avoided by

- (a) Select a suitable instrument for particular measurement application.
- (b) After determining instrument errors, apply correction factors.
- (c) The instrument must be re-calibrated carefully.

### (ii) Environmental Errors:

→ Due to changes in the environment surrounded by the instrument that may affect the instrument characteristics, such as temperature, humidity, pressure, magnetic field (or) electrostatic field.

- These errors can be avoided by:
- (a) air conditioning
  - (b) Hermetically sealing certain components in the instrument and
  - (c) using magnetic shields.

### (iii) Observational Errors:

- These errors are caused due to observer. Ex: parallax errors.
- These are caused by habits of individual observers.
- To minimize parallax errors, modern instruments have digital outputs.

### (3) Random (or) accidental errors:

→ These are found even the gross and systematic errors are minimized.

→ The accumulation of large number of small effects causes these type of errors.

→ These are caused due to

- (a) Certain Human errors: Inconsistency in estimating successive readings from the instrument by an observer.
- (b) Errors caused due to disturbance in equipment.
- (c) Errors caused due to fluctuating experimental conditions.



# Dynamic characteristics:

Type of instrument needed depends upon the type of data.

- 1. Steady state data: If data varies in the range of 0-5 Hz.
- 2. Transient data: If the parameters variation is at much higher rate (greater than 5 Hz).
- 3. Dynamic data: If the parameters variation is periodic.

Static characteristics indicate response of slow varying data (or time invariant data). Instrument testing, design and evaluation is performed based on these parameters.

The dynamic behaviour of an instrument is determined by subjecting its primary element (sensing element) to some known predetermined variations in the measured quantity. The three most common variations in measured quantity are:

## 1. Step input:

This represents sudden, instantaneous and finite change in the input. Ex: Sudden application of force to mechanical system, instantaneous closing of switch in electrical circuits etc.

→ The step input of magnitude A is denoted as  $Au(t)$  and shown in fig

Its Laplace transform

$$F(s) = \frac{A}{s}$$

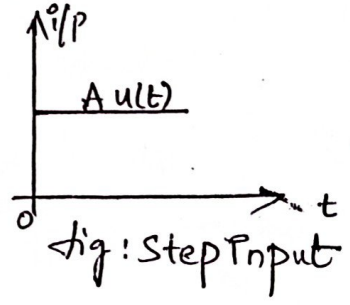

## 2. Ramp input:

This represents linear change in input. The input i.e. measured variable varies linearly with time. It is denoted with  $Au(t)$

Laplace transform

$$F(s) = \frac{A}{s^2}$$

when  $A=1 \Rightarrow$  Unit ramp

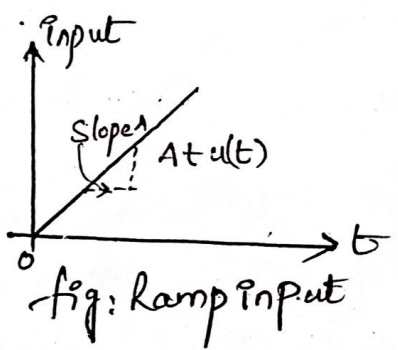



### 3. Sinusoidal input :

This represents an input which changes in accordance with a sinusoidal function of constant amplitude. The frequency is independent variable in this case.

Analysing the dynamic behaviour includes the study of variations in output amplitude and phase as input is sinusoidal.

→ The sinusoidal input is given as  $A \sin \omega t$

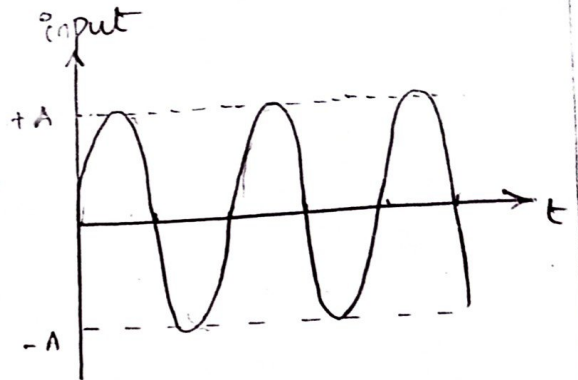

fig: Sinusoidal input

Laplace transform 
$$F(s) = \frac{A\omega}{s^2 + \omega^2}$$

→ The various dynamic characteristics of instrument are :-

1. Speed of response
2. Fidelity
3. Lag
4. Dynamic error

#### 1. Speed of responses

It is the rapidity (or) quickness of the instrument with which it responds to the sudden change in the input signal. It indicates the activeness of the system. It is also stated as the total time taken by the system to come closer to steady state condition.

#### 2. Fidelity (faithful reproduction)

Degree to which an instrument indicates the change in the measured variable without any dynamic error. The perfect fidelity is obtained by a zero order system i.e. fidelity is the degree of nearness with which the output reproduces the time varying input with in a conversion factor.

### 3) Lag:

Every system takes some time, whatever small it may be, to respond to the changes in the measured variable. This retardation or delay in the response is called lag. It is also called measuring lag. It is of two types:

#### (a) Retardation lag:

In this case, the response of the system begins immediately after a change in the variable, has occurred.

#### (b) Time delay:

In this case, response begins after some time called dead time, after the application of input. This shift causes dynamic errors.

### 4) Dynamic Errors

It is the difference between true value of the quantity to be measured to the value indicated by the instrument, assuming zero static errors.

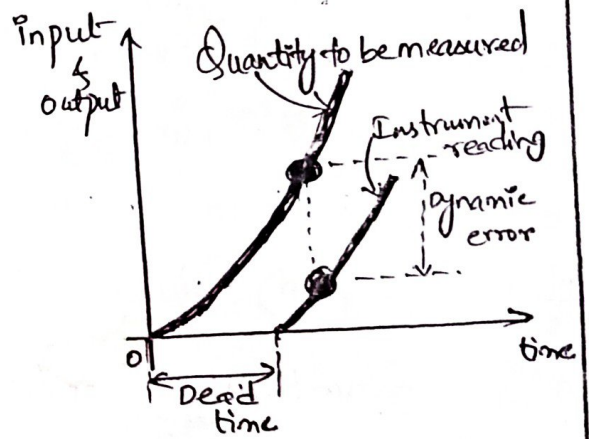

Fig: Dynamic characteristics



## DC - Voltmeter

- The Most commonly used DC-voltmeter is based on fundamental principle of the motor.
- Motor action is produced by a small amount of current through a moving coil which is positioned in a permanent magnetic field.
- This basic moving system is called as "D'Arsonval movement".
- A basic D'Arsonval movement can be converted into dc-voltmeter by adding a series resistor known as multiplier.

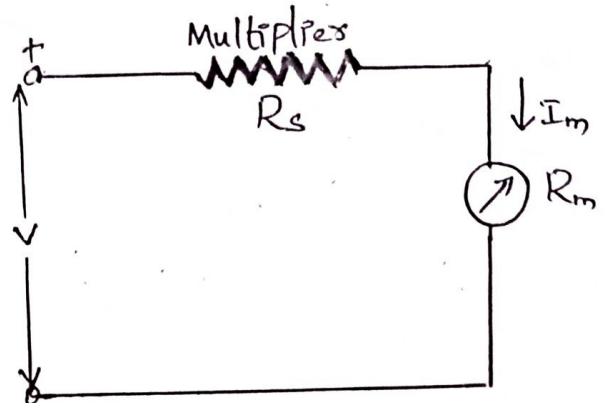

fig. Basic dc-Voltmeter

- The function of the multiplier is to limit the current through the movement so that the current does not exceed the full scale deflection (FSD) value.
- A dc-voltmeter measures the potential difference between two points in a dc-circuit.
- Always dc-voltmeter is connected in parallel with proper polarity.
- The value of the multiplier required is given as :

$I_m$  = Full scale deflection current of the movement ( $I_{fcd}$ )

$R_m$  = Internal resistance of the movement

$R_s$  = Multiplier resistance

$V$  = full range voltage of the instrument

from fig ①  $\Rightarrow V = I_m (R_s + R_m)$

$$R_s = \frac{V - I_m R_m}{I_m}$$

$$\therefore R_s = \frac{V}{I_m} - R_m$$

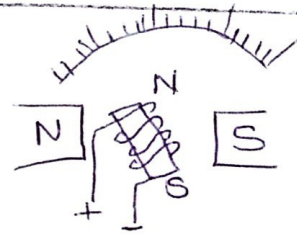

D'Arsonval Principle

The multiplier limits the current through the movement, so as to not exceed  $I_{fsd}$ .

### Multirange Voltmeter

→ A number of shunt resistances are connected across the movement with a multiple positioned switch.

→ figure ① shows a multi-range voltmeter using three position switch, and three multipliers  $R_1$ ,  $R_2$  &  $R_3$ ,

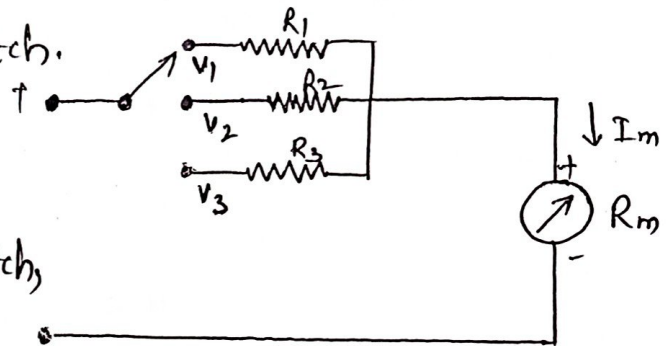

fig ①: multi range voltmeter

for voltage values  $V_1, V_2, V_3$ .

→ fig ① can be modified further to improve the practical arrangement

→ fig ② is more practical arrangement of multiplier resistors of multi range voltmeter.

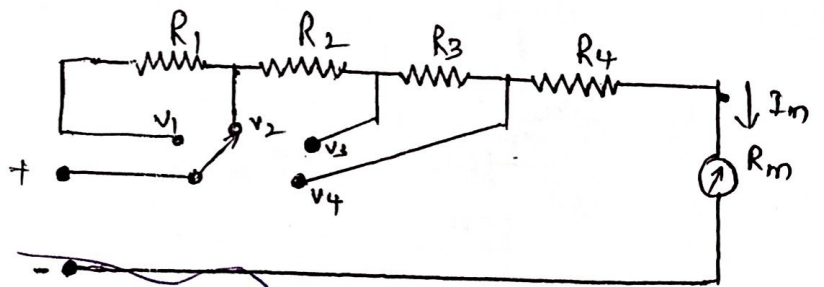

fig ②: Multipliers connected in series string.

→ Here multipliers are connected in series string, and range selector selects the appropriate amount of resistance required in series with movement.

→ The first resistance (or) low range multiplier  $R_4$ , is specially manufactured to meet the circuit requirements.



examples Convert a basic D'Arsonval movement with an internal resistance of  $50\Omega$  and full scale deflection current of  $2\text{mA}$  into a multirange dc-voltmeter with voltage range of  $0-10\text{V}$ ,  $0-50\text{V}$ ,  $0-100\text{V}$  &  $0-250\text{V}$ .

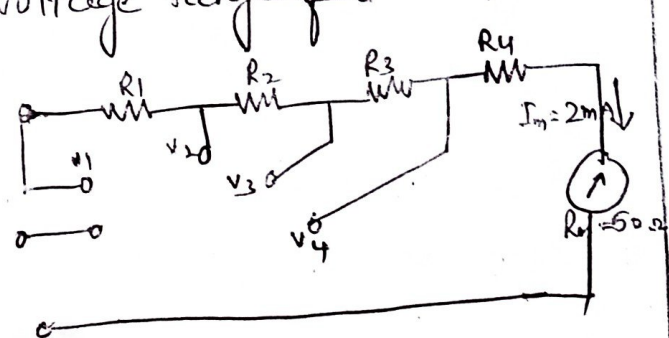

Sol: for  $10\text{V}$  range ( $V_4$  position of switch), the total resistance

$$R_t = \frac{V}{I_{fsd}} = \frac{10}{2\text{mA}} \Rightarrow 5\text{K}\Omega$$

$$\therefore R_4 = R_t - R_m \Rightarrow 5000\Omega - 50\Omega = 4950\Omega \Rightarrow \underline{4.95\text{K}\Omega}$$

→ for  $50\text{V}$  range ( $V_3$  position), the total circuit resistance

$$R_t = \frac{V}{I_{fsd}} \Rightarrow \frac{50^{25}}{2 \times 10^{-3}} = \underline{25\text{K}\Omega} \text{ (or) } 25000\Omega$$

$$R_3 = R_t - R_m - R_4 \Rightarrow 25000 - (50 + 4950) = 25\text{K} - 5\text{K} = \underline{20\text{K}\Omega}$$

→ for  $100\text{V}$  range ( $V_2$  position), the total resistance

$$R_t = \frac{V}{I_{fsd}} = \frac{100}{2 \times 10^{-3}} \Rightarrow 50\text{K}\Omega$$

$$R_2 = R_t - (R_m + R_4 + R_3) \Rightarrow 50,000 - (50 + 4950 + 20,000) \Rightarrow 50\text{K} - 25\text{K}$$

$$\boxed{R_2 \Rightarrow \underline{25\text{K}\Omega}}$$

→ for  $250\text{V}$  ( $V_1$  position), the total resistance  $R_t$  is given as

$$R_t = \frac{V}{I_{fsd}} \Rightarrow \frac{250}{2 \times 10^{-3}} = 125\text{K}\Omega$$

$$R_1 = R_t - (R_m + R_4 + R_3 + R_2) = 125,000 - (25\text{K} + 20\text{K} + 4950 + 50) \Rightarrow 125\text{K} - 50\text{K} = \underline{75\text{K}\Omega}$$

## Extending Voltmeter range:

→ The range of a voltmeter can be extended to measure high voltages.

→ This is achieved by using an external multiplier resistor & By using high voltage probe.

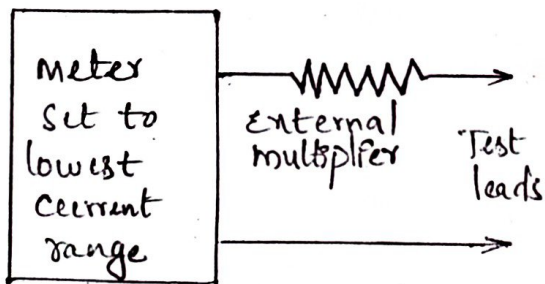

fig: extending voltage range

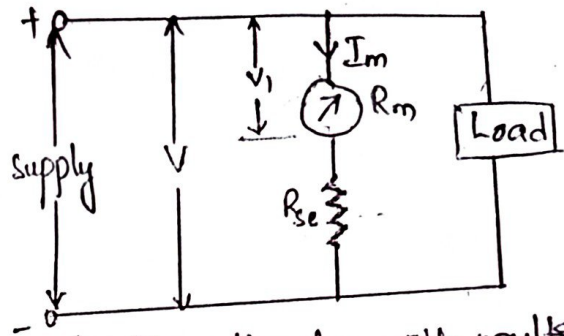

fig ②: voltmeter with multiplier

where  $V \rightarrow$  Device full range voltage

$V_1 \rightarrow$  Voltage across the basic meter movement.

$R_{se} \rightarrow$  Series resistance

$I_m \rightarrow$  full scale deflection current of the movement

$R_m \rightarrow$  Internal resistance of the coil.

from fig ②  $\Rightarrow V_1 = I_m R_m$  ——— ①

$V = I_m R_m + I_m R_{se}$  ——— ②

$V = I_m (R_m + R_{se})$

$\therefore R_{se} = \frac{V}{I_m} - R_m$

The multiplication factor of the multiplier is given by,

$m = \frac{V}{V_1}$

$\therefore m = \frac{I_m (R_m + R_{se})}{I_m R_m}$

$m = \left( 1 + \frac{R_{se}}{R_m} \right)$

$R_{se} = R_m (m - 1)$  ——— ③

eq ③ is called resistance of multiplier



Voltmeter Sensitivity = (ohms per volts rating of voltmeter)

It is the ratio of total circuit resistance to the voltage range.

It is the reciprocal of full scale deflection current represented by 'S', given as

$$S = \frac{1}{I_{fsd}}$$

Sensitivity of a dc-voltmeter is used to calculate the value of multiplier resistor i.e.

$$R_{se} = R_T - R_m \quad \& \quad R_T = S \times V$$

$$R_{se} = (S \times V) - R_m$$

$R_T \rightarrow$  Total resistance

$$R_T = R_{se} + R_m$$

$S \rightarrow$  Sensitivity of voltmeter

$V \rightarrow$  voltage range set by switch

$R_m \rightarrow$  internal resistance.

$\rightarrow$  Calculate the value of multiplier required for the multirange dc-voltmeter as shown in figure below.

Sol: Sensitivity  $S = \frac{1}{I_{fsd}}$

$$= \frac{1}{50 \times 10^{-6}} = 80000 \Omega$$

$$S = 20 \text{ k}\Omega/\text{V}$$

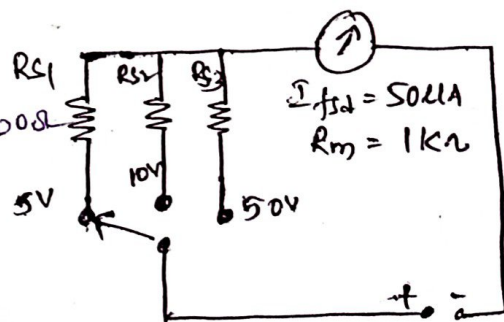

for 5V range the value of multiplier resistance is

$$R_{s1} = (S \times V) - R_m \Rightarrow 20 \text{ k} \times 5 - 1 \text{ k} = 100 \text{ k} - 1 \text{ k} = \underline{99 \text{ k}\Omega}$$

for 10V range the value of multiplier resistance is

$$R_{s2} = (S \times V) - R_m \Rightarrow 20 \text{ k} \times 10 - 1 \text{ k} = 200 \text{ k} - 1 \text{ k} \Rightarrow \underline{199 \text{ k}\Omega}$$

for 50V range the value of multiplier resistance is

$$R_{s3} = (S \times V) - R_m \Rightarrow 20 \text{ k} \times 50 - 1 \text{ k} = 1000 \text{ k} - 1 \text{ k} \Rightarrow \underline{999 \text{ k}\Omega}$$

$\therefore R_{s1} = 99 \text{ k}\Omega$ ;  $R_{s2} = 199 \text{ k}\Omega$ ;  $R_{s3} = 999 \text{ k}\Omega$  respectively

## Solid state voltmeter:

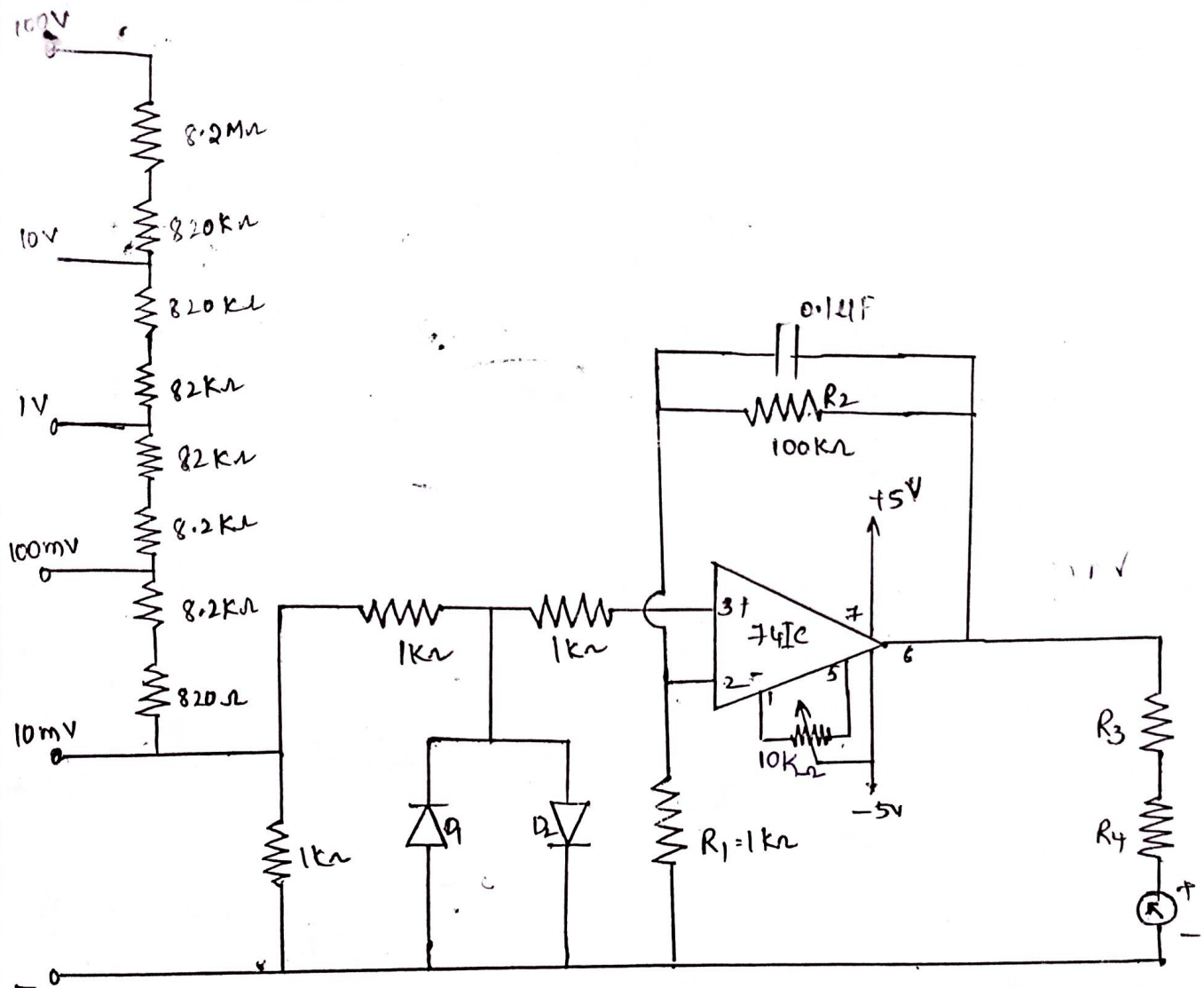

fig: solid state 'mv' voltmeter using IC 741C opamp.

- Solid state voltmeters are directly coupled, very high gain amplifiers.
- The ratio of  $R_2/R_1$  determines gain. with terminals 1 & 5 as offset null terminals.
- To provide a negative feedback, a resistance ' $R_2$ ' is connected to pin 6 to pin 7.
- from the figure, the gain  $\frac{R_2}{R_1} = \frac{100k\Omega}{1k\Omega} \Rightarrow \boxed{100 = \text{gain}}$
- A 10kΩ potentiometer is connected between 1 & 5, used for adjusting zero output for zero input.



- The two diodes  $D_1, D_2$  are used for protecting the IC. Under normal conditions they are non-conducting, as maximum voltage across them is 10mV.
- If excess voltage ( $> 10\text{mV}$ ) appears across them, then one of the diode conducts and protects IC.
- A 50-1000 $\mu\text{A}$  full scale deflection can be used as an indicator.  $R_4$  is adjusted to get maximum f.s.d (full scale deflection).

## Differential Voltmeters

### Basic differential voltmeter. (or) potentiometric Voltmeter

→ It is one of the most common and accurate methods of measuring unknown voltages.

→ In this technique, a voltmeter is used to indicate the difference between the known and unknown voltages,

i.e. an "unknown voltage is compared with known voltage."

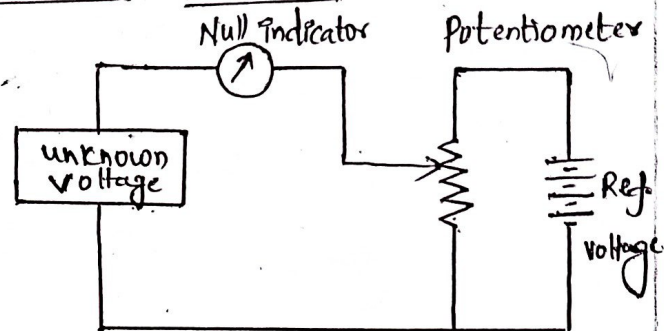

fig: Basic differential voltmeter

→ From the fig the potentiometer is varied until the voltage across it equals the unknown voltage, indicated by null indicator as zero.

→ Under null condition, the meter draws current neither from the reference source nor the unknown voltage source.

→ To detect small differences the meter movement should be sensitive.

→ The reference source is usually a 1V dc standard, <sup>source or a</sup> ~~Zener diode~~ controlled precision supply.

# AC - differential Voltmeters

→ In order to convert AC-voltages into dc a typical AC-differential voltmeter uses a precision rectifier circuit.

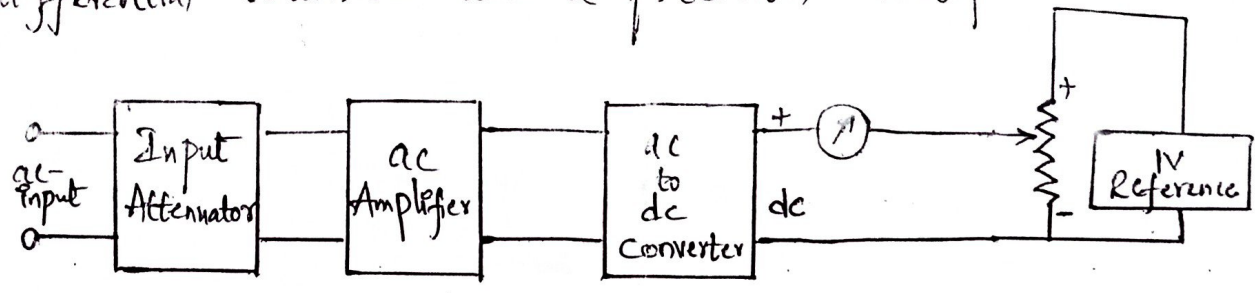

fig: Block diagram of AC differential voltmeter

## AC voltmeter:

→ A rectifier type instruments generally use PMMC (Permanent magnet moving coil) movement along with a rectifying arrangement.

→ Silicon diodes are preferred due to their low reverse current and high forward current ratings.

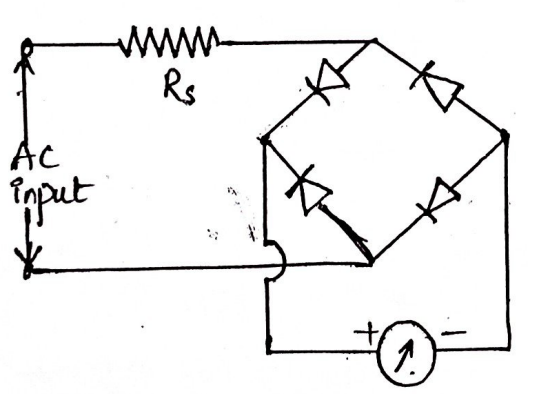

fig: AC voltmeter

67-30

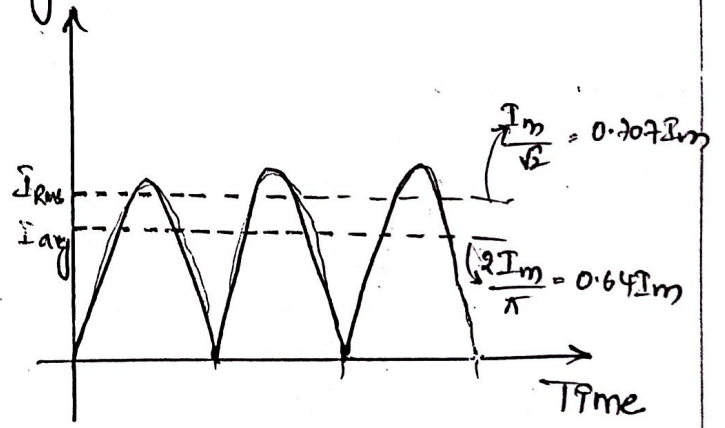

fig: Rms and average value of current

→ A rectifier bridge produces a full wave DC signal as its input. The steady deflection is proportional to the average value of the current ( $I_{avg}$ ) as shown in fig (3).



→ The meter scale is usually calibrated to give RMS value of alternating sine wave input.

→ In the reverse bias, rectifier exhibits capacitance properties which bypass high frequencies.

→ Thus the ac voltmeter reading may be in error by 0.5% decrease for every 1 kHz rise in frequency.

→ In figure (c) the diode  $D_1$  conducts during positive half of the input cycle and the meter deflects in accordance to the average value of the <sup>half</sup> cycle.

→ The meter movement is shunted by the resistor ( $R_{sh}$ ) in order to draw more current through  $D_1$  and for linearization.

→ The diode  $D_2$  conducts during negative half cycle of AC input and current passes through the measuring circuit in opposite direction. This current bypasses the meter movement.

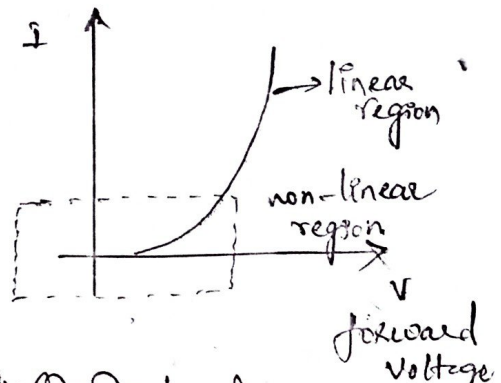
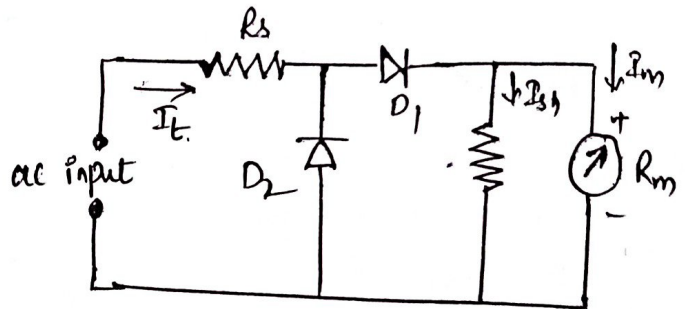

fig (3) = Diode Characteristics



(c) fig: general rectifier-type AC-voltmeter

## Multi-range Ac-voltmeter :

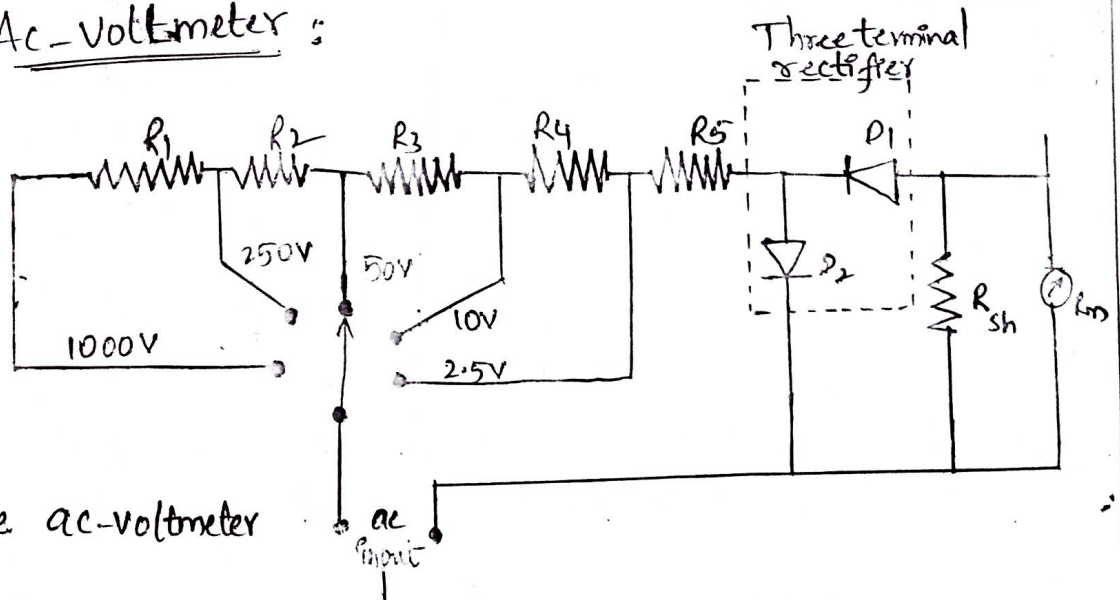

Fig: multirange ac-voltmeter

- The basic circuit for measuring ac voltages for different ranges is shown in the above figure.
- The resistances  $R_1$ ,  $R_2$ ,  $R_3$  and  $R_4$  form a chain of multipliers for voltage ranges of 1000V, 250V, 50V, 10V and ~~2.5V~~.
- The resistor  $R_5$  acts as a multiplier whose voltage range is 2.5V.
- In order to improve rectification operation  $R_{sh}$  is acted as shunt in meter.

## Range extension of an AC voltmeter:

- An AC voltmeter is a rectifier type device which uses PMMC (Primary-magnetic-moving-coil) movement along with rectifier arrangement.
- The basic circuit is shown below, with 4 diodes used in rectifying elements form a full wave rectifier bridge.



→ Rectifier element converts AC to unidirectional DC and a meter responsive to DC is used to indicate the value of rectified.

→ Generally Si diodes are used in the bridge rectifiers since it has high forward current and low reverse current.

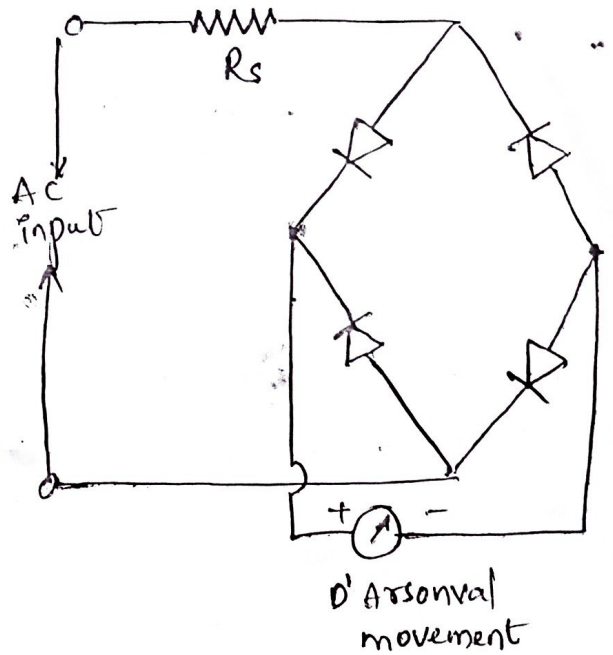

→ In the figure the value of current is limited by multiplier " $R_s$ " ( $I_m \leq I_{FSD}$ )  
the dc sensitivity of rectifier type device is

$$S_{DC} = \frac{1}{I_{FSD}}$$

$I_{FSD} \rightarrow$  Full scale deflection current

→ The AC sensitivity of the device is different for half-wave rectifier and full wave rectifier.

For half-wave rectifier :  $S_{AC} = 0.45 S_{DC}$  — (1)

For Full-wave rectifier :  $S_{AC} = 0.9 S_{DC}$  — (2)

eq (1) & (2) are not valid for non-sinusoidal input waveforms

→ Consider ' $V$ ' applied voltage and  $V_1$  as voltage drop across PMMC instrument then

→ To extend the range of half wave rectifier for AC-Voltmeter the value of multiplier is

$$R_s = S_{AC} V - R_m - R_d$$

$$R_s = 0.45 S_{DC} V - R_m - R_d \quad (\because S_{AC} = 0.45 S_{DC})$$

To extend the range of full wave rectifier for AC-voltmeter the value of multiplier is

$$R_s = 0.95 S_{DC} V - R_m - 2R_d$$

$R_d \rightarrow$  Resistance across diodes

Shunt (or) Ayrton shunt:  $\star\star$  (To avoid extra shunt in Ammeter)

→ It is also known as universal shunt.

→ The shunt meter improves the sensitivity of the meter.

→ From the figure the series

combination of  $R_2, R_3$  and the meter movement is in parallel with

$R_1$  when the switch  $S_1$  is connected in position "1".

→ Therefore the current through the meter movement is less than the current through the shunt, thereby it protects the meter movement.

→ In position "2" the series combination of  $R_3$  and meter movement is in parallel with resistors  $R_1$  and  $R_2$ . ~~Here~~ Here also  $I_{sh} < I_{meter}$

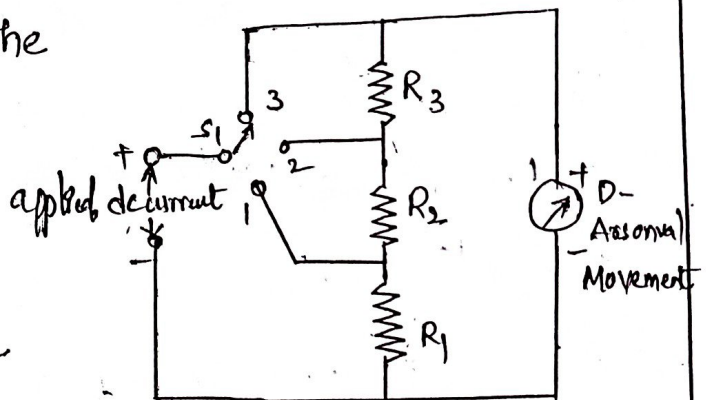



→ where  $I_{sh}$  → current through shunt resistance.

$I_{meter}$  → current through meter.

→ In position "3"  $R_1, R_2$  &  $R_3$  are parallel with meter movement, now the current flowing through the  $I_{sh}$  is very less whereas  $I_{meter}$  is high (very).

→ Thus the sensitivity of the meter movement increases by Ayrton shunt.

### Thermo Couple type AC ammeter

→ A Thermocouple is a device which produces the voltage in accordance to the temperature change (heating) element.

→ It consists of two metals which forms a junction, the current to be measured is used to heat the junction of two metals. Then they produce a voltage proportional to heating effect.

→ The output voltage is driven by a sensitive DC-ammeter. This gives a reading proportional to the magnitude of AC input.

→ The alternating current heats up the junction where the heating effect is same for both half cycles of the AC, because the polarity is always having same magnitude.

→ Various types of thermocouples are available which work on the principle of Thermoelectric action.

### (a) Mutual type thermocouple ammeter :

→ Here the AC-current passes through the thermo-couple itself and not through a heating wire. The sensitive DC ammeter shunts the thermocouple which is the basic drawback of this device.

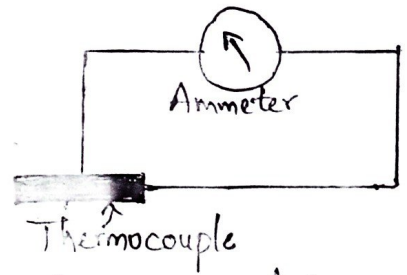

fig: mutual type thermocouple

### (b) Contact type thermocouple Ammeter :

→ These are low sensitive devices compared to mutual type.

→ In figure, X-Y is the thermocouple element. It separates thermocouple leads, that conduct away the heat from metal wire of heater.

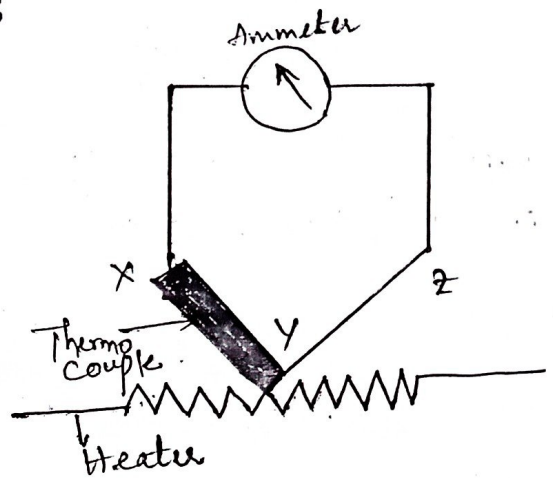

fig: Contact type thermocouple

### (c) Separate heater type

→ In this type of ammeter, the thermocouple is held near the heater but not in contact and insulated by a glass bead.

→ This makes the instrument less sensitive as the temperature drops in the glass bead.

→ In RF current measurements this type of arrangement is preferred.

→ To increase sensitivity of the instrument it is placed in vacuum.

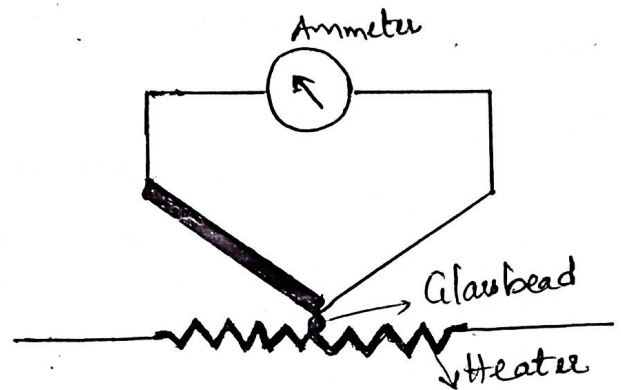



## Bridge types

- This is one of mutual type of thermocouple instrument. Sensitivity of this device is high.
- This type avoids the shunting effect of the ammeter.

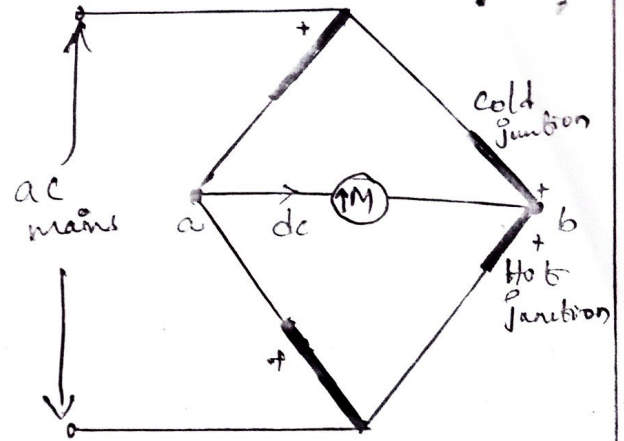

- There is no requirement of heating element, the electric current which directly passes through the thermocouple raises the temperature i.e.

fig: Bridge type thermocouple

$T_a$  → Temperature at point a  
 $T_b$  → Temperature at point b

$$T_a - T_b \propto I^2 R$$

- The connected meter between the junctions a and b will show the potential difference between them.

## Ohmmeters

- These are the instruments used to measure resistance.
- They are mainly divided into two types.
  1. Series type
  2. Shunt type

### Series type ohmmeter

- In the figure the resistor  $R_1$  and the battery  $V$  are connected in series with D'Arsonval movement.
- The unknown resistance ' $R_x$ ' is connected between A & B.

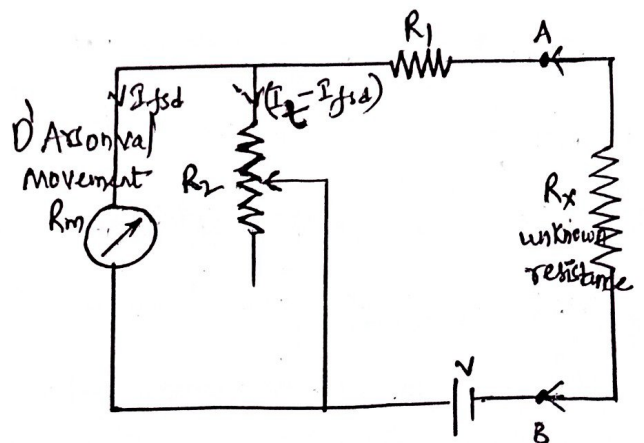

fig: series type ohmmeter

→ The current flowing through the movement ~~the~~ depends on the magnitude of unknown resistance.



Fig: Dial of series ohmmeter.

→ Therefore, the meter deflection is directly proportional to the value of unknown resistance.

### Calibration of the series type Ohmmeter:

- Initially the terminals A and B are shorted, therefore the current through unknown resistance ( $R$ ) is maximum i.e.  $R_x = 0$ .
- In this case maximum current flows through the circuit. The resistor  $R_2$  connected in shunt adjusts until the movement on scale shows full scale current  $I_{fsd}$ . This position is marked as '0 Ω' on the scale.
- In the same way, to mark "∞" on the scale, the terminals A & B are open circuited.
- Therefore the current through  $R_x$  is zero i.e.  $R_x = ∞$ . In this case no current flows through circuit and the pointer does not show any deflection. This position of pointer is marked as "∞ Ω".
- Intermediate markings on the scale are corresponded to various unknown value of resistances ( $R_x$ ) connected across A and B terminals.
- Due to time and ageing problem, the battery 'V' voltage connected in series decreases. Thus even  $R_x = 0 Ω$  the scale cannot show it as  $0 Ω$ . To bring pointer to  $0 Ω$ , the zero adjusting resistor ( $R_2$ ) is connected across meter movement.



- The full scale deflection current is adjusted by varying  $R_1$ .
- The value of  $R_1$  is very high compared to  $R_m$ .
- Instead of varying  $R_1$  for full scale current representation by decreasing  $R_1$  the current flowing through the meter increases
- This brings pointer to full scale deflection position.
- The value of  $R_1$  and  $R_2$  are determined from the value of  $R_h$  which gives half the full scale deflection.

$$R_h = R_1 + (R_2 \parallel R_m) = R_1 + \frac{R_2 R_m}{R_2 + R_m}; \quad R_h = \text{half of full scale deflection resistance}$$

- The total current resistance presented in the battery is  $2R_h$  and the battery current needed to supply half deflection is  ~~$I_h$~~

$$I_h = \frac{V}{2R_h}$$

To produce full scale current the battery current has to be doubled.

$$\therefore \text{total current of circuit } I_t = \frac{V}{R_h}$$

Shunt current through  $R_2$  is  $I_2 = I_t - I_{fsd}$

- the voltage across shunt is equal to voltage across meter

$$V_{sh} = V_m$$

$$I_2 R_2 = I_{fsd} R_m$$

$$R_2 = \frac{I_{fsd} R_m}{I_2} \quad \text{--- (1)}$$

but  $I_2 = I_t - I_{fsd}$  — (2)

sub eq (2) in (1)  $\Rightarrow R_2 = \frac{I_{fsd} R_m}{I_t - I_{fsd}}$  — (3)

but  $I_t = \frac{V}{R_h}$

eq (3)  $\Rightarrow R_2 = \frac{I_{fsd} R_m}{V/R_h - I_{fsd}} \Rightarrow \boxed{\frac{I_{fsd} R_m R_h}{V - R_h I_{fsd}} = R_2}$

but  $R_h = R_1 + \frac{R_2 R_m}{R_2 + R_m}$

$\therefore R_1 = R_h - \frac{R_2 R_m}{R_2 + R_m}$

$R_1 = R_h - \frac{\left(\frac{I_{fsd} R_m R_h}{V - R_h I_{fsd}}\right) R_m}{\left(\frac{I_{fsd} R_m R_h}{V - R_h I_{fsd}}\right) + R_m}$

$\boxed{R_1 = R_h - \frac{I_{fsd} R_m R_h}{V}}$

Thus  $R_1$  &  $R_2$  can be determined.

### Shunt type ohmmeters

→ It consists of a battery in series with an adjustable resistor  $R_1$  and a D'Arsonval movement.

→ The unknown resistance is connected in parallel with meter, hence it is shunt type.

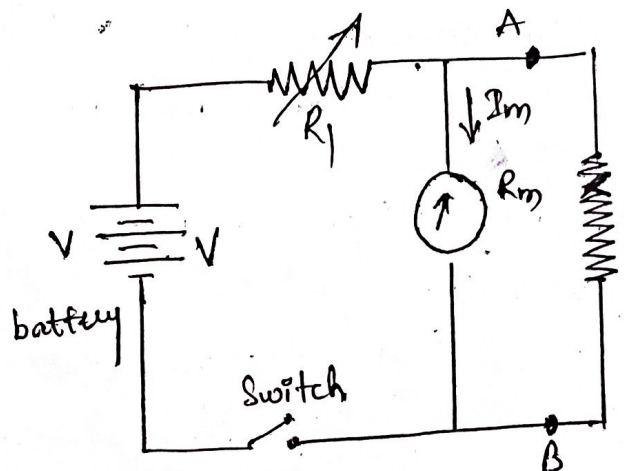

figs shunt type voltmeter



## Calibration on shunt type ohmmeter

→ To make "0" reading on the scale, terminals A and B are shorted i.e. the unknown resistance  $R_x = 0$ , and the current through the meter movement is zero.

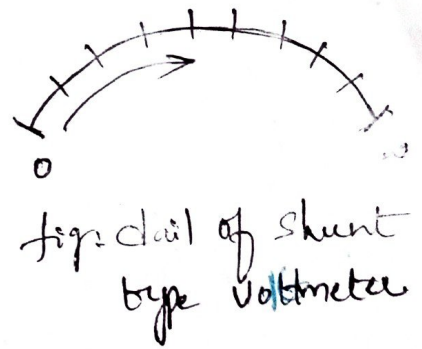

→ Similarly to make "10" reading on the scale, the terminals A and B are opened i.e. the unknown resistance  $R_x = \infty$  and current through the meter is full scale reading.

→ Intermediate markings can be done by connecting the known values of standard resistors to A and B.

→ This type is mostly suited for low resistance measurements

→ Hence it is used as a test instrument in laboratories for low resistance applications.

<u>series type ohmmeter</u>	<u>shunt type ohmmeter</u>
<ol style="list-style-type: none"><li>1) It does not have on/off switch.</li><li>2) The dial has 0 on right side and 10 on left.</li><li>3) For high resistance measurements.</li><li>4) <math>R_f</math> and battery are in series with meter.</li><li>5) The battery voltage of series type ohmmeter decreases with time and ageing.</li></ol>	<ol style="list-style-type: none"><li>1) It consists of on/off switch.</li><li>2) The dial has 0 on left side and 10 on right side.</li><li>3) For low lab purpose resistance measurement.</li><li>4) <math>R_f</math> and battery are in parallel to meter.</li><li>5) The battery voltage of shunt type ohmmeter is not decreased with time and age.</li></ol>